

Maximum Transparency and Freedom of Design with
Aluminium Sliding and Lifting-Sliding Doors by heroyal

Splendid Views and Special Moments.



heroyal



FEEL FREE, SAFE AND PROTECTED.

Your living space has great potential – use it: with sliding and lifting-sliding doors by heroyal you visually extend your living space to the outside. Enjoy best heat insulation and a high level of security with the sliding and lifting-sliding doors closed. These are features creating a genuine added value: in everyday life and for very special moments in your life.



- 04 Design: suits every architectural style
- 06 Structural Shapes: extensive and flexible
- 08 Variety: for light and transparency
- 10 Insulation: for soundproofing and energy efficiency
- 12 Security: for a feeling of safety
- 14 Configuration: to your preferences

DESIGN: SUITS EVERY ARCHITECTURAL STYLE

Whether in tune with your windows or in a favourite colour – the design of your sliding and lifting-sliding door is up to you. Choose from a variety of designs to adapt your sliding and lifting-sliding door to the individual architectural style of your house.



Thanks to our factory coating service, heroal sliding and lifting-sliding doors offer maximum freedom of design. All heroal coating variants stand for especially durable and weather-resistant surfaces, protection against UV radiation, as well as colour and gloss retention. The high weather resistant **heroal hwr powder coating** offers you all the colours of the extensive RAL colour chart. In addition to this wide range of colours, you can also choose between different gloss rates – from dull matt through brilliant to metallic – with the most subtle nuances within one shade. The coating procedure **heroal Surface Design (SD)** enlarges the design options by a whole variety of looks, such as elegant wooden or modern concrete surfaces. The heroal coating service is complemented by the **exclusive Les Couleurs® Le Corbusier partnership**, so you can also choose from the 63 exclusive Le Corbusier colour shades.

Les Couleurs® Le Corbusier

The exclusive partnership between heroal and Les Couleurs® Le Corbusier offers you a unique colour spectrum. The nature-inspired colours can be harmoniously combined, have unrivalled aesthetics, represent spatial effects and meet the demand for fine-tuned colourings.



803 l'ocre rouge clair



631 le rubis



817 terre d'ombre brûlée 31



819 ombre naturelle moyenne



765 gris foncé 31



767 gris moyen



781 céruleen clair



777 outremer gris



heroyal hwr powder coating

The high weather resistant heroyal hwr powder coating provides for long-lasting colour stability. All colours of the extensive RAL colour chart can be applied – in different gloss rates: ranging from dull matt through brilliant to metallic.

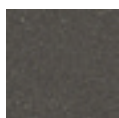

0812 Sepia



32 light beige

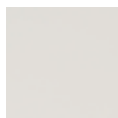

61 cream



88.10 ice-grey

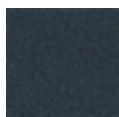

0841 RAL 7016

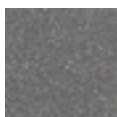

0793 RAL 9007

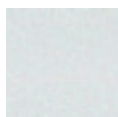

26 Eloxal



0578 white

heroyal SD

The surface refining heroyal SD enlarges the creative possibilities and offers particular resistibility and a high finishing comfort. First the sliding and lifting-sliding door is heroyal hwr powder-coated and then refined in the required design.

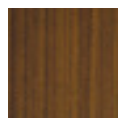

301 raw walnut



302 light cherry



307 golden oak



306 light douglas

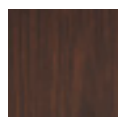

308 walnut



310 swamp oak



312 rust



313 concrete

The complete range of colours is on display in colour fans available to you. Due to printing techniques, the colours shown here may differ from the original.

STRUCTURAL SHAPES: EXTENSIVE AND FLEXIBLE

Whether for a patio, balcony or conservatory – heroyal sliding and lift-ing-sliding doors offer the right solution for every building situation. They create rooms flooded with light and make a consistent design possible – in tune with the façade of your house.



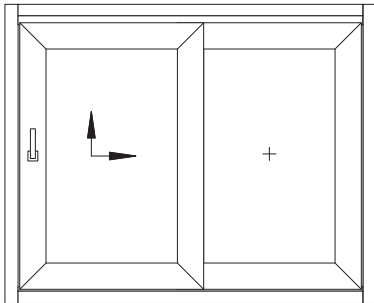

One operating sash, opening left

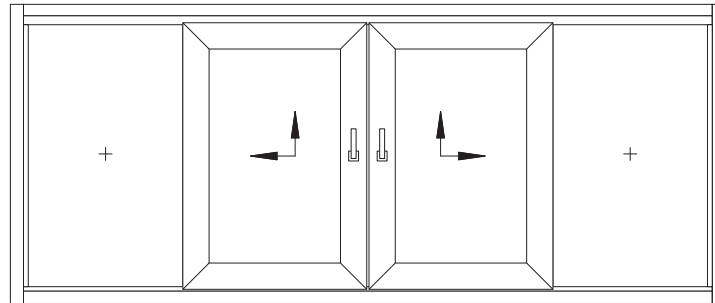

Two operating sashes, opening outwards

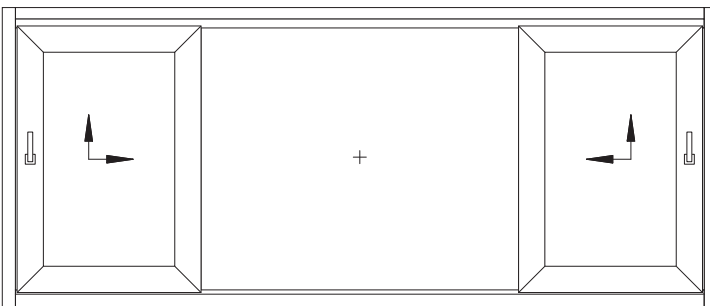

Two operating sashes, opening inwards

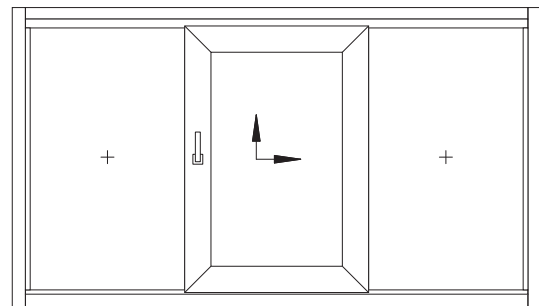

One operating sash (centre), opening right

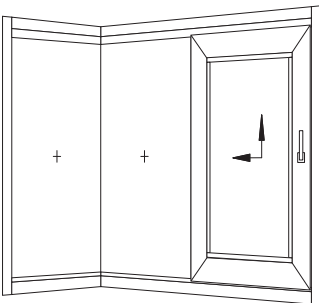

90°-fully glazed corner,
one operating sash, opening left

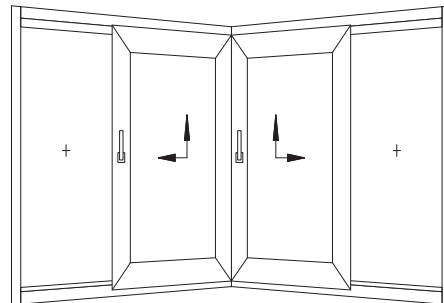

90°-corner for opening,
two operating sashes, opening outwards

Freedom of design: the **opening modes, configurations, colouring** and **heroal technology**, taking into account even the tiniest detail, leave nothing to be desired.

Sliding and lifting-sliding doors by heroal offer customized solutions for your requirements and are available in numerous configurations: depending on the operating mode requested, sliding and lifting-sliding doors can be designed with **single, double or triple track frame** and with **up to six operating sashes**. That way, sliding and lifting-sliding doors can not only be adapted to individual requirements, but they are also suited for especially large building openings. The 90°-corner provides maximum transparency and open panoramas, available with fixed glazing or with operating sashes.

VARIETY: FOR LIGHT AND TRANSPARENCY

Light, open rooms open up comfortable surroundings: large glazed elements create transparency and visually connect the outside with the interior room. With sliding and lifting-sliding doors by heroyal you can significantly extend your living space.



Large glazed elements, pure materials and light, open rooms creating friendly surroundings characterise today's modern architecture. The high-end sliding and lifting-sliding doors by heroyal are designed to meet this demand – they create maximum transparency due to small face widths.

The fully glazed corner variant allows lots of light to flood in and a particular open feel to your home. The sliding and lifting-sliding door heroyal S 77 SL is available as a 90°-corner with fixed glazing or as moveable element. Neither bars nor pillars block the way to or the view of the outside.



Lifting-sliding doors are opened by lifting and then sliding sideways, without any existing friction between the seals of the sash and the frame. That way, the sash can be opened and closed very easily. A smooth-running lever mechanism makes sure that even especially large elements can be moved without any problem, providing for open living environments. Lowering the sash on the frame when closing also increases tightness. Lifting-sliding doors can be designed barrier-free and as flush-type zero-barrier. In order to increase the ease of use even further, lifting-sliding doors can also be opened and closed automatically.

Sliding doors are opened and closed only by sliding, without lifting the sash. As opposed to a lifting-sliding door, a sliding door can be produced and installed with less effort. In addition, the fitting technology to be used is less complex. Just as lifting-sliding door, sliding doors can be designed barrier-free and as flush-type zero-barrier.

INSULATION: FOR SOUNDPROOFING AND ENERGY EFFICIENCY

Sliding and lifting-sliding doors have quite a lot to deliver: each and every day, their energy efficiency and soundproofing need to be effective. Sliding and lifting-sliding doors by heroyal meet these high demands.



Highest heat insulation values are achieved by special insulating zones: sliding and lifting-sliding doors by heroyal can achieve **U_w -values of $\geq 1.0 \text{ W/m}^2\text{K}$** .

Large glazed elements do not necessarily mean higher heating cost: sliding and lifting-sliding doors by heroyal satisfy all energetic requirements. Due to the sophisticated makeup of the sash profiles, they create an optimal room climate and lower energy costs. High-quality insulating materials and innovative design features reduce the temperature difference between the outside and inside of the sliding and lifting-sliding door. The higher surface temperature on the inside of the door improves the comfort, particularly when the house is heated. This is due to the fact that currents of cool air are not created by the doors. Draughts occur when warm room air cools down on cold surfaces, moves down to the floor and that way creates a problematical air current. With heroyal products, you effectively reduce draughts and enhance a comfortable room atmosphere.

But not only that: with sliding and lifting-sliding doors by heroyal you also benefit from top scores when it comes to soundproofing. At home, you can not only enjoy the extra light and comfort, but also the peace and quiet you long for. Test the effect of soundproofing here:

www.heroal.de/schallschutztest





SECURITY: FOR A SAFE FEELING

Maximise transparency and incoming light, minimise the risk of burglaries: sliding and lifting-sliding doors by heroyal are made of high-grade aluminium and have special security features – the ideal protection of your home.





Avoid weak spots: in single-family houses, **40.7 % of burglars use the patio door to enter.**

Most burglars gain access via the patio door. Very often, the patio is secluded, protected against prying eyes by a surrounding garden with plants. Thus, burglaries occur in secrecy, burglars identify and exploit the patio door as a weak spot.

Sliding and lifting-sliding doors by heroyal provide a high level of security. In order to increase resistance to burglary, heroyal sliding and lifting-sliding doors are equipped with anti-lift devices, drill protections, floor-mounted locks as well as lockable handles. They also offer an additional safeguard when both sashes join for closing.

Resistance classes (RC) indicate, how efficient burglary protection actually is: from RC 1 (basic protection) to RC 4 (high protection), also withstanding experienced perpetrators using battery drills. heroyal lifting-sliding doors are rated resistance class RC 2, which is also recommended by the police. If further equipped with heroyal roller shutters, sliding and lifting-sliding doors are even certified up to resistance class RC 3.

CONFIGURATION: TO YOUR PREFERENCES

Sliding and lifting-sliding doors by heroal are made of aluminium – so you benefit from best functionality, wide design options and dependable durability. Choose the solution that meets your requirements best.



Smart Home

- Compatible with all standard smart home systems and Bluetooth
- Opening and closing possible via app

Configuration

- Multi-track design variants
- Up to six operating sashes
- Fully glazed corner (with operating sash or fixed glazing)
> please see page 7

heroal SF drive

- Motor drive system for particularly convenient and noiseless operation
- Controllable at the push of a button, via wireless remote control, smartphone, integration in smart home systems possible
- Recognizes obstructions independently and stops at the slightest resistance

Burglary resistance

- With anti-lift devices, drill protection, floor-mounted locks and central joint safeguard as well as lockable handles
- Resistance class RC 2 rated

Operation

- Fittings with soft-close technology
- Robust heroal stainless steel sliding rail
- Automatic opening and closing possible

Surfaces

- All colours of the RAL colour chart available
- All 63 colour shades of Les Couleurs® Le Corbusier available
- Different gloss rates and surface refinement heroal SD, e.g. walnut, possible
> please see page 5

Threshold

- Barrier-free with a maximum design height of the threshold of 20 mm
- Zero-barrier without threshold

Made in Germany
heroal



heroal S 77



heroal S 77 SL

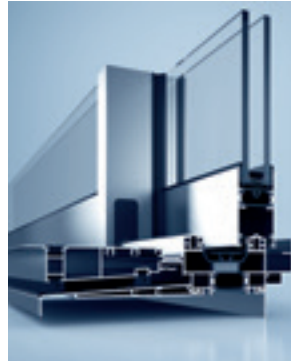

heroal S 42

Whether the classical variant **heroal S 77** with up to six operating sashes or the design-oriented **90°-corner heroal S 77 SL**, lifting-sliding doors by heroal offer best heat insulation and burglary resistance. The sliding door **heroal S 42** stands out for filigree looks and maximum cost and energy efficiency.



Lifting-Sliding handle



Sliding handle



„Design“ handle



Inset handle

Design the detail: the selection of **handles** with looks like silver anodized, dark bronze or stainless steel complete the spectrum of design options.



heroal SF Drive

Comfortable operation: **heroal SF Drive** provides your heroal lifting-sliding door with an **electric drive** and **locking sensors**. You can control it at the push of a button or connect it to your **smart home system**.

The concept of heroal sliding and lifting-sliding doors is that of a flexible system. Based on this concept, they can be installed in all building situations without any problem and are in perfect harmony with other heroal systems, like entrance door, windows, façade, roller shutters, roller door as well as insect screens or sun protection. The product development of sliding and lifting-sliding doors by heroal focused on ease of use, as always. Even large door elements can be moved easily. Their functional reliability is not impaired even after long years of use - this is guaranteed by regular tests in our own heroal test bay.

Apart from the structural shape, your own personal requirements, e.g. with respect to heat insulation, soundproofing and burglary resistance, are the decisive factors for choosing the sbest system for you.



sun protection
Joe Smith

Nequis ut ium, que eum aut audant estiunt andit quibus maximol
uptatem. Itatum eatiaero omnis et faccum quae coria simaximus
eaquat harum in premqueArios a nus, te nonsed magnam sitiis
que duci tem landistiat la culliquam ilignim inctus sunit, qui ali-
geniatur mint possitatem volum core cum quidesseque nullic tem
et fuga. Occuptur, ant, ut aut que quam, custia nus dolo que

We design, supply and install

- windows
- doors
- curtain walls
- patio roofs

Get to know us and convince yourselves.

sun protection Jow Smith

Construction Street 4
12345 Sample City

Phone +44 0 12 34 56 78-9

Fax +44 0 12 34 56 78-0

info@sun-protection.co.uk

www.sun-protection.co.uk

Individualization for heroal customer



heroal develops and produces high-quality and innovative aluminium system solutions for **roller shutters, sun protection, roller doors, windows, doors and curtain walls.**

heroal systems set standards in terms of innovation and „Made in Germany“ quality and have received several awards.

www.heroal.com