

**NEW**

**Doors and wicket doors with thermal break, depth 67 mm**



# Industrial Sectional Doors

With the innovative wicket door with trip-free threshold

 door  
 studio  
[www.doorstudio.ca](http://www.doorstudio.ca)







Brand Quality from Hörmann	4
Sustainable production	6
Good reasons to try Hörmann	8
Door fixtures and fittings	10
Application areas	12
SPU F42	
SPU 67 Thermo	16
APU F42	
APU F42 Thermo	
APU 67 Thermo	20
ALR F42	
ALR F42 Thermo	
ALR 67 Thermo	24
APU F42 S-Line	
ALR F42 S-Line	28
ALR F42 Glazing	
ALR 67 Thermo Glazing	
ALR F42 Vitraplan	32
ALR F42 for on-site facade design	36
Wicket doors	40
Side doors	44
Colours	46
DURATEC glazing with scratch resistance	48
Glazing types	50
Thermal insulation	52
Track versions	54
Advanced technology in every detail	56
Safety features	57
Manually operated doors	58
Handles	59
Compatible system solutions	60
Leading photocell, light grille	62
Operators, controls	66
Operator accessories	74
Performance characteristics	82
Construction and quality features	84
Hörmann product range	86



Copyright: No part or excerpt may be reproduced without our prior permission.  
Subject to changes. The doors shown are example applications – no guarantee.

Image on left: fire brigade in Langenfeld (ALR F42)

# Hörmann Brand Quality

## Reliable and Oriented Towards the Future



VW original parts logistics, Ludwigsfelde (near Berlin)



### In-house product development

At Hörmann, innovation is produced in-house – highly qualified employees are in charge of product optimisation and new developments. This results in market-ready, high-quality products that are very popular around the globe.



### Modern manufacturing

All of the essential door and operator components, such as sections, frames, fittings, operators and controls are developed and manufactured by Hörmann. This guarantees a high degree of compatibility between the door, operator and controls. Our certified quality management system ensures the highest quality, from development through to production and delivery.

**This is Hörmann quality – Made in Germany.**



As Europe's leading manufacturer of doors, hinged doors, frames and operators, we are committed to high product and service quality. This is how we set standards on an international scale.

Highly-specialised factories develop and manufacture construction components that are characterised by excellent quality, functional safety and a long service life.

Our presence in the global economy's key regions makes us a strong, future-oriented partner for industrial and public construction projects.



Energy savings compass  
You can find the interactive planning aid on the Internet at [www.hormann.co.uk/energysavingscompass](http://www.hormann.co.uk/energysavingscompass)



It goes without saying that spare parts for doors, operators and controls are original Hörmann parts that come with a guaranteed availability of 10 years.



### Competent advice

Experienced specialists within our customer-oriented sales organisation support you from the planning stage, through technical clarification up to the final building inspection. Complete working documentation, such as technical manuals, is not only available in printed form, but it is always accessible and up-to-date at [www.hoermann.com](http://www.hoermann.com)



### Fast service

Our extensive service network means that we are always nearby and at your service. This is a great advantage for testing, maintenance and repairs.

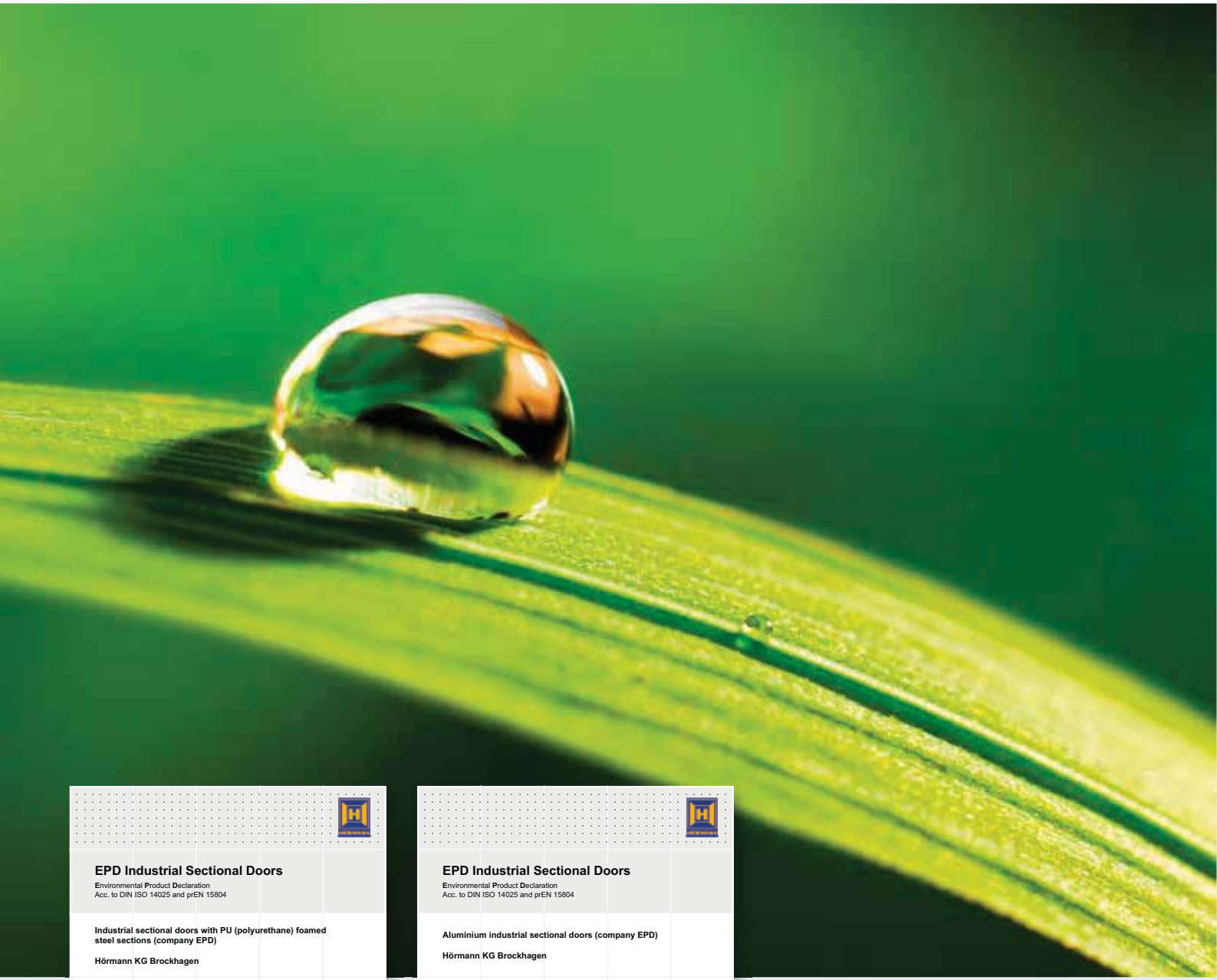

# Sustainable production

## For future-oriented construction



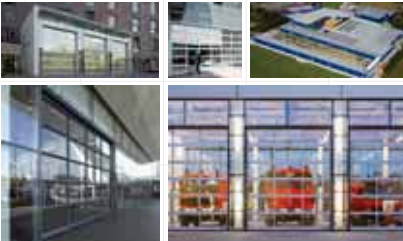

	
<b>EPD Industrial Sectional Doors</b> Environmental Product Declaration Acc. to DIN ISO 14025 and prEN 15804	
<b>Industrial sectional doors with PU (polyurethane) foamed steel sections (company EPD)</b> Hörmann KG Brockhagen	
	
Declaration number EPD-STPU-0.3	
	

EPD industrial sectional doors with PU foamed steel sections

	
<b>EPD Industrial Sectional Doors</b> Environmental Product Declaration Acc. to DIN ISO 14025 and prEN 15804	
<b>Aluminium industrial sectional doors (company EPD)</b> Hörmann KG Brockhagen	
	
Declaration number EPD-STAl-0.3	
	

EPD aluminium industrial sectional doors

<b>We Think Green</b> Hörmann is taking responsibility for the environment and for future

Find out more about Hörmann's environmental activities in the "We think green" brochure.

## Sustainable production: Industrial sectional doors from Hörmann

### Ecological quality

A comprehensive energy management system ensures environmentally friendly production, e.g. by using the heat from the production systems to warm the building.

### Economic quality

A long service life and low maintenance costs thanks to the use of high-quality materials, such as DURATEC glazing.

### Functional quality

Large, energy-saving glazing, as well as door constructions with thermal breaks, enable optimum energy efficiency in the building.

### Process quality

By further processing mono-material plastic waste from the production process, material resources are saved.

## Sustainability verified and documented by the IFT in Rosenheim

Hörmann is the only manufacturer who already received confirmation of the sustainability of all its industrial sectional doors through an environmental product declaration (EPD) in accordance with DIN ISO 14025 and EN 15804 from the Institut für Fenstertechnik (ift – Institute of window technology) in Rosenheim. The inspection was based on the Product Category Rules (PCR) "Doors and Gates". Environmentally-friendly production was confirmed by a life-cycle analysis in accordance with DIN EN ISO 14040 / 14044 for all industrial sectional doors.

## Sustainable construction with Hörmann competence

Hörmann has already been able to gain great expertise in sustainable construction through various projects. We also apply this know-how to support your projects.

## References for sustainable construction with Hörmann



ThyssenKrupp, Essen



dm logistics centre, Weilerswist



Immogate logistics centre, Munich

**Nordex-Forum, Hamburg**

**Unilever Hafen-City, Hamburg**

**Deutsche Börse, Eschborn**

**Opernturm, Frankfurt**

**Skyline-Tower, Munich**

**Prologis Pineham Sites, Sainsbury**



Institut Bauen  
und Umwelt e.V.



**breem**

# Good reasons to try Hörmann

The market leader has the innovations

Only from Hörmann



# 1

## A permanently clear view

### Maximum scratch resistance

Doors with DURATEC synthetic glazing stand up to tough demands in rough industrial environments, while maintaining their transparency. A special surface coating, similar to that used on car headlights, protects the pane over the long-term from scratches and damage caused by cleaning.

**The DURATEC glazing is available as standard and at no extra charge in all sectional doors with synthetic glazing – only from Hörmann.**

For further information, see pages 48 – 51.



Take a look at the video at:  
[www.hoermann.com](http://www.hoermann.com)



PATENT PENDING

Only from Hörmann



# 2

## Efficient thermal insulation

### ThermoFrame

Well-insulated industrial sectional doors are essential in heated buildings. Hörmann industrial sectional doors are optionally available with the ThermoFrame frame connection for a thermal break between frame and brickwork. Additionally, lip seals on both sides of the door and a double seal in the lintel area protect from heat or cold loss, increasing the thermal insulation value by up to 21 %.

For further information, see pages 52 – 53.



**World's first  
Wicket door construction  
with thermal break, depth 67 mm**

EUROPEAN PATENT

**Only from Hörmann**

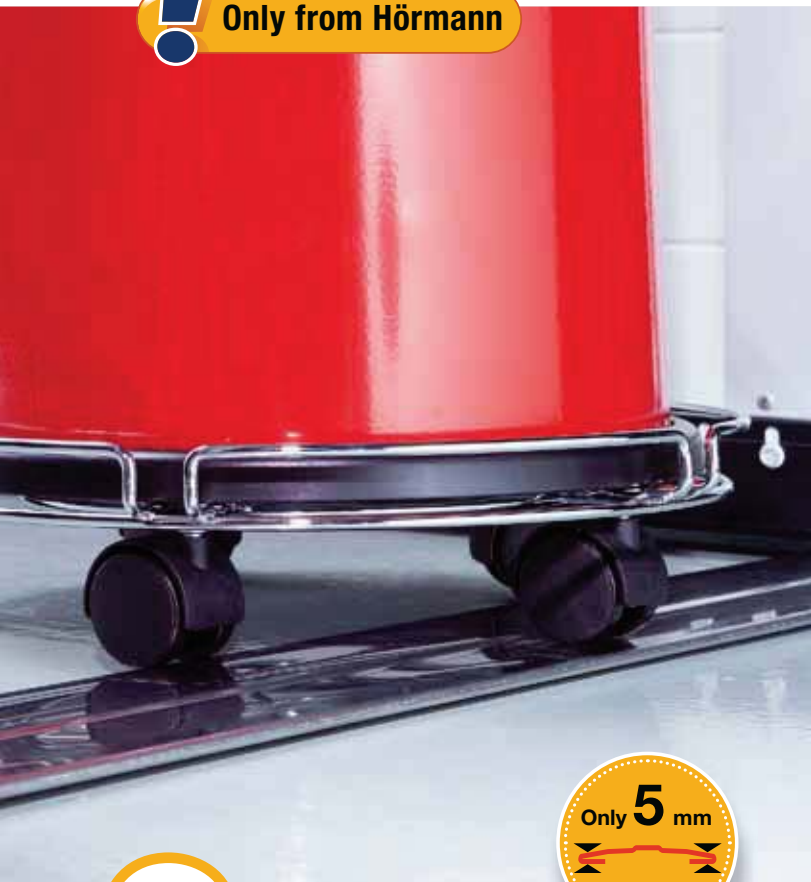

**Only from Hörmann**



**3**

**Practical  
solutions**

**Wicket door with trip-free threshold**

The wicket door with extra-flat stainless steel threshold ensures easier passage of pedestrians. With doors with a width up to 5510 mm, the threshold rail is only 10 mm high in the middle and 5 mm high at the edges, reducing the risk of tripping considerably and making it easier to wheel things through. Under certain circumstances, Hörmann wicket doors with trip-free threshold can even be used as escape doors and for barrier-free construction.

For further information, see pages 40 – 43.



Take a look at the video at:  
[www.hoermann.com](http://www.hoermann.com)



**4**

**Non-contact  
door monitoring**

**Leading photocell without surcharge**

All power-driven Hörmann industrial sectional doors are equipped with a self-monitoring closing edge safety device with optosensors as standard. You can also select the leading photocell VL 1 for non-contact monitoring of the closing edge without a surcharge. The light grille HLG can also be optionally integrated into the frame. **These solutions offer you increased safety, faster door action and lower inspection and maintenance costs.**

For further information, see pages 62 – 63.

**NEW  
No surcharge**

# Door fixtures and fittings

## Section thicknesses, surface finishes and profile types

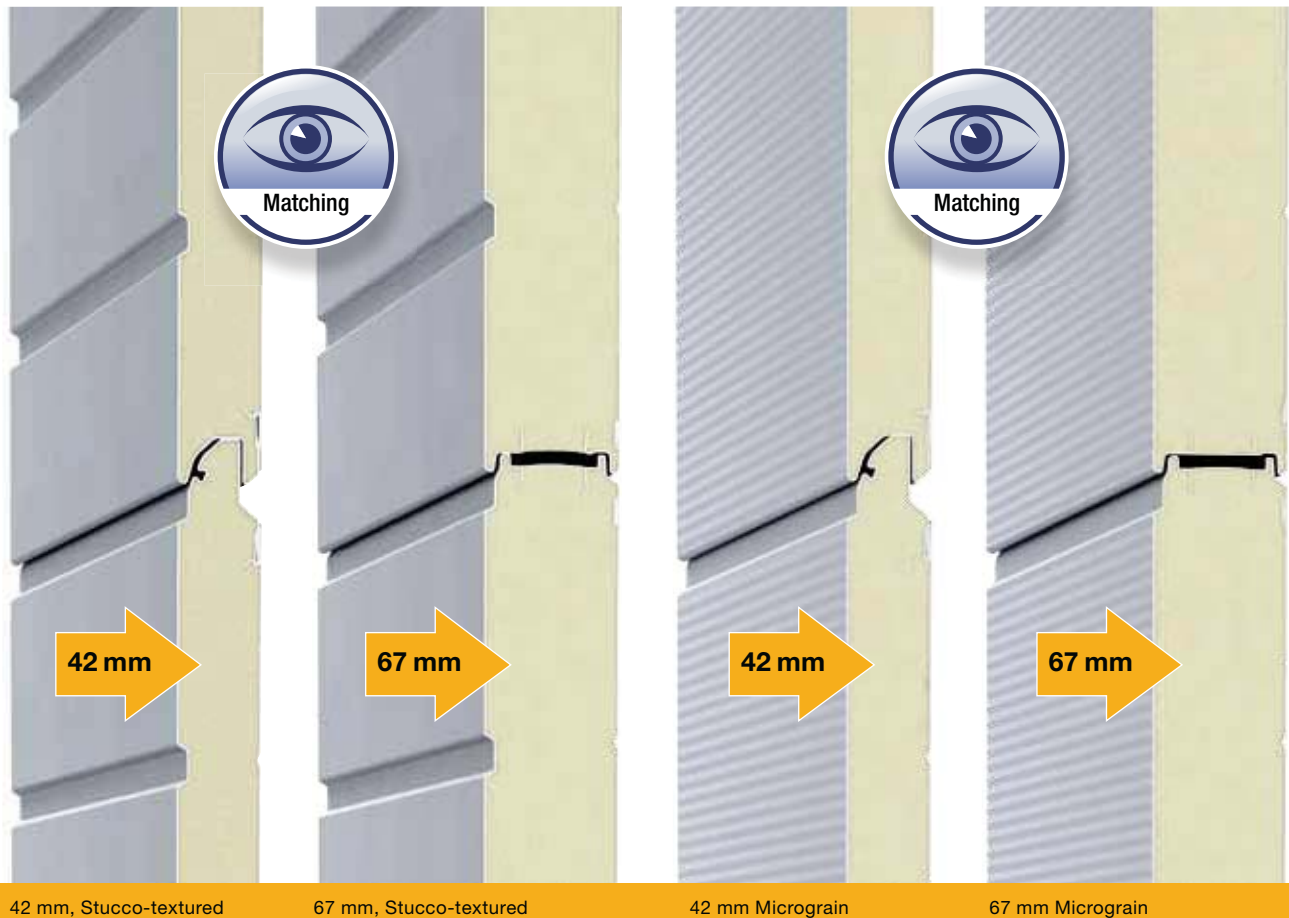

### PU-foamed sectional doors in 2 surfaces and 2 depths

PU-foamed sectional doors are available either with 42 mm depth or with sections with thermal break and 67 mm depth. For both versions, the door appearance is 100 % matching.

#### Depth 42 mm

Hörmann sectional doors with a 42-mm-thick PU-foamed section are especially robust, offering good thermal insulation.

#### Depth 67 mm

##### with the best thermal insulation ■ NEW

With the SPU 67 Thermo's 67 mm section with thermal break, you benefit from an excellent thermal value of up to  $0.51 \text{ W}/(\text{m}^2 \cdot \text{K})^*$ . The thermal break between the exterior and interior of the steel sections also reduces the formation of condensation water on the inside of the door.

The surface finish of the sections of steel doors or doors with bottom sections is based on hot-galvanized sheet steel and a high-adhesion primer-coating (2-component PUR) that protect the door against adverse effects of the weather.

#### Resistant Stucco surface

Additionally, Stucco texturing gives the door surface a uniform structure on which light scratches or traces of dirt are more difficult to see.

#### Micrograin surface finishes give an elegant look

Micrograin features a smooth surface and characteristic fine lines. This door surface finish harmonises especially well with modern facades that are characterised by their clear formal structure. The inside of the door is Stucco-textured in Grey white, RAL 9002, as standard.

\* For a door size of 5000 x 5000 mm with optional ThermoFrame

**NEW**

**67 mm thermal profiles with thermal break**



42 mm standard profile

42 mm S-Line profile

42 mm Thermo profile

67 mm Thermo profile

## Glazed aluminium doors in 4 profile types and 2 depths

### Standard profile, depth 42 mm

As standard, the glazing frames are produced using high quality aluminium extrusion profiles that are designed for robust industrial and commercial day-to-day work. The standard profile without thermal break is ideal for buildings that are barely or not at all heated or cooled.

### S-Line profile, depth 42 mm

The narrow S-Line frame construction features a vertical and horizontal profile that is only 65 mm wide in the section transitions and can be integrated harmoniously into modern, large glass facades. Thanks to its characteristic trapezoidal symmetry with chamfered edges, the S-Line profile gives a very attractive appearance. The invisible section transitions are equipped with seals and finger trap protection.

### Thermo profile with thermal break, depths 42 mm and 67 mm

The Thermo profiles with thermal breaks on the interior and exterior are the first choice everywhere where the thermal insulation of the building is important. The 67-mm Thermo profile with 3 chamber system is delivered with triple glazing as standard. The 42-mm Thermo profile is delivered with double glazing as standard. Other glass variants, e.g. climatic glass or synthetic quadruple pane, can further increase the energy efficiency.

## Application areas

A matching door version for every purpose

### Save energy thanks to thermal insulation

SPU F42  
SPU 67 Thermo  
Double-skinned steel sectional doors

Page 14



### More light in the building

APU F42  
APU F42 Thermo  
APU 67 Thermo  
Glazed aluminium doors with steel bottom section

Page 20



### Fitting in modern architecture

ALR F42  
ALR F42 Thermo  
ALR 67 Thermo  
Glazed aluminium doors

Page 24



## Elegant and stylish

APU F42 S-Line  
ALR F42 S-Line

Glazed aluminium doors  
with invisible section  
transitions

Page 28



## Display windows and elegant eye-catchers

ALR F42 Glazing  
ALR 67 Thermo Glazing  
ALR F42 Vitraplan

Exclusively glazed  
aluminium doors

Page 32



## Door and facade design

ALR F42  
for on-site cladding  
Aluminium doors

Page 36



# SPU F42

## Double-skinned steel sectional doors



### Logistics buildings and warehouses

Easy and safe passage of pedestrians thanks to the wicket door with trip-free threshold

### Commercial buildings

Bring natural light into the building using optional glazing



**Everything from one source:  
Industrial doors, dock levellers, dock shelters**



**Agriculture**  
Robust thanks to PU-foamed panels



**Logistics**  
Operator WA 300 S4 (see page 66),  
the affordable solution for logistics doors



# SPU 67 Thermo

Double-skinned steel sectional doors with thermal break



## Logistics

Excellent thermal insulation with sections with thermal break, depth 67 mm

## Fresh logistics

The SPU 67 Thermo door minimises temperature losses at door openings, making it ideal for use in food and cold logistics







**Excellent thermal insulation  
with a U-value of up to 0.51 W/(m<sup>2</sup>·K)**



**Commercial buildings**

Easy and safe passage of pedestrians thanks to a wicket door with thermal break and trip-free threshold



**Commercial buildings and warehouses**

Bring natural light into the building using optional glazing



## SPU F42

**1** The 42-mm-thick PU-foamed section with finger trap protection is especially robust and offers a good thermal insulation. The door leaf is available in the Stucco-textured and Micrograin surface variants.

## SPU 67 Thermo // NEW

**2** Optimum thermal insulation is achieved with the SPU 67 Thermo, featuring 67-mm-thick sections with thermal break without finger trap protection\*. Both surface variants for the door leaf match the SPU F42.



\* In the available size range, these doors comply with the requirements in EN 13241-1

Door type	SPU F42		SPU 67 Thermo	
	without wicket door	with wicket door	without wicket door	with wicket door
<b>Door size</b>				
Max. width (mm)	8000	7000	10000	7000
Max. height (mm)	7500	7500	7500	7500

**Thermal insulation EN 13241-1, Appendix B EN 12428**  
U-value in W/(m<sup>2</sup>·K) for a door surface 5000 × 5000 mm

Solid sectional door	1.0	1.2	0.62	0.82
With ThermoFrame	0.94	1.2	0.51	0.75
Section	0.50	0.50	0.33	0.33

## Optimum thermal insulation in 2 section surface finishes

The PU-foamed sections are particularly robust and offer good thermal insulation. Especially with the 67-mm-thick sections you benefit from very high thermal insulation, achieved through the thermal break between the interior and exterior of the steel sections. This also minimises the formation of condensation water on the inside of the door. You can choose between Stucco-textured and Micrograin for the surface finish, both without a surcharge. The Stucco-textured surface features uniform ribbing every 125 mm in the section and in the section transition.



Sections with thermal break in SPU 67 Thermo

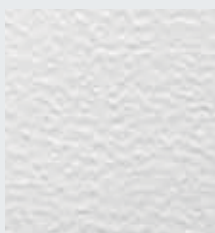

Stucco-textured

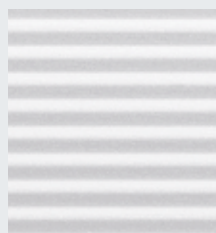

Micrograin

Colour options page 47  
Glass types page 51  
Safety features in acc. with EN 13241-1, page 57.  
Technical data page 82

## Example door versions

Door width up to 4500 mm (example 4500 × 4500 mm)



SPU F42, SPU 67 Thermo  
Type A section windows  
uniform field division

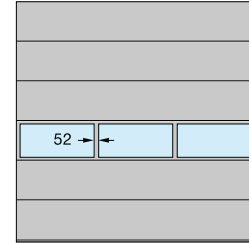

SPU F42, SPU 67 Thermo  
Aluminium glazing frames  
uniform field division

Door width up to 5500 mm (example 5500 × 4500 mm)

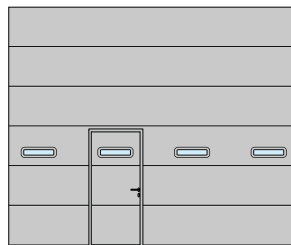

SPU F42, SPU 67 Thermo  
Type D section windows  
wicket door to the left

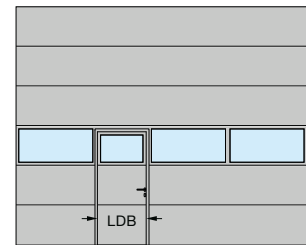

SPU F42, SPU 67 Thermo  
Aluminium glazing frames  
wicket door to the left

Door width over 5500 mm (example 7000 × 4500 mm)

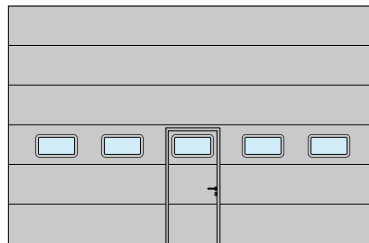

SPU F42  
Type E section windows  
wicket door in the centre

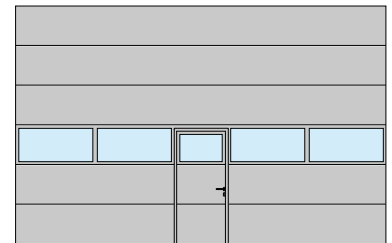

SPU F42, SPU 67 Thermo  
Aluminium glazing frames  
wicket door in the centre

Clear passage width (LDB)  
SPU F42: 940 mm  
SPU 67 Thermo: 905 mm

## SPU F42 Plus In the same appearance as sectional garage doors

On request, the SPU F42 Plus is available in the same door styles and surface finishes as Hörmann sectional garage doors.

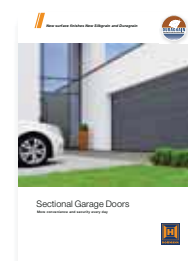

For more detailed information, please see the Sectional Garage Door brochure.

# APU F42, APU F42 Thermo, APU 67 Thermo

Glazed aluminium doors with steel bottom section



## Workshops

Large glazings for light in the workspace



## Commercial buildings and warehouses

The PU-foamed bottom section can be replaced easily and inexpensively if damaged, for example, by a vehicle.

## Protection bollards protect from damage

When used outside, they avoid expensive collision damage on buildings. When used inside, they protect the door tracks from collision damage.

*Especially easy to service and repair thanks to robust bottom sections*



**Workshops**

Easy and safe passage of pedestrians thanks to the wicket door with trip-free threshold



**Industrial halls**

Permanent clear view thanks to standard DURATEC glazing

# Glazed aluminium doors with steel bottom section



## APU F42

**1** Thanks to the combination of robust bottom sections and large glazings, the door is especially stable and lets a lot of light into the building.

## APU F42 Thermo

**2** The APU F42 Thermo with glazing beads with thermal break is recommended for high thermal insulation requirements.

## APU 67 Thermo **NEW**

**3** The APU 67 Thermo, depth 67 mm, offers excellent thermal insulation thanks to its glazing beads and steel sections with thermal break.



Door type	APU F42		APU F42 Thermo		APU 67 Thermo	
	without wicket door	with wicket door	without wicket door	with wicket door	without wicket door	with wicket door
<b>Door size</b>						
Max. width (mm)	8000	7000	7000	7000	10000	7000
Max. height (mm)	7500	7500	7500	7500	7500	7500

### Thermal insulation EN 13241-1, Appendix B EN 12428

U-value in W/(m<sup>2</sup>·K) for a door surface 5000 × 5000 mm

Standard double pane	3.4	3.6	2.9	3.1	–	–
With ThermoFrame	3.3	3.6	2.8	3.1	–	–
Standard triple pane	–	–	–	–	2.1	2.3
With ThermoFrame	–	–	–	–	2.0	2.2
Optional climatic double pane, single-pane safety glass	2.5	–	2.0	–	1.6	–
With ThermoFrame	2.4	–	1.9	–	1.5	–

**APU 67 Thermo: Excellent thermal insulation  
with a U-value of up to 1.5 W/(m<sup>2</sup>·K)  
for a door size of 5 × 5 m**

**Robust bottom section**

The 750-mm-high bottom section is optionally available in Stucco or Micrograin surface finish without surcharge. It is particularly robust due to the uniform PU foaming in the steel section. With larger damages, it can be exchanged easily and inexpensively.

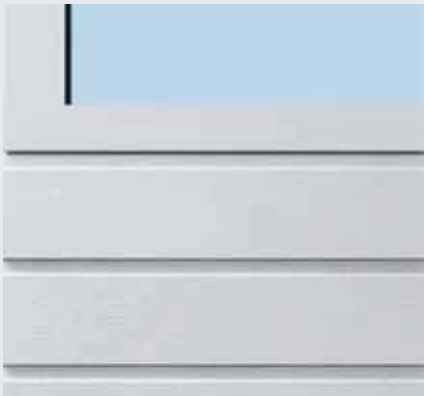

Stucco-textured bottom section



Micrograin bottom section

**Example door versions**

**Door width up to 4500 mm** (example 4500 × 4500 mm)

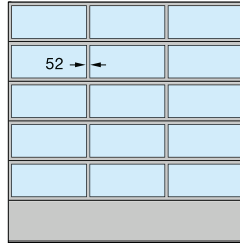

APU F42, APU F42 Thermo,  
APU 67 Thermo  
uniform field division

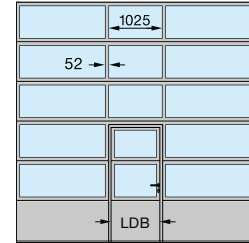

APU F42, APU F42 Thermo,  
APU 67 Thermo  
wicket door in the centre

**Door width up to 5500 mm** (example 5500 × 4500 mm)

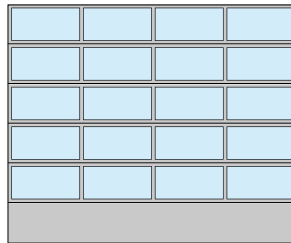

APU F42, APU F42 Thermo,  
APU 67 Thermo  
uniform field division

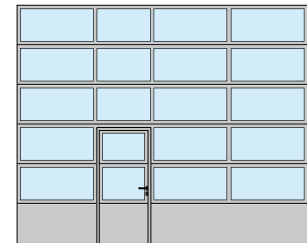

APU F42, APU F42 Thermo,  
APU 67 Thermo  
wicket door to the left

**Door width over 5500 mm** (example 7000 × 4500 mm)

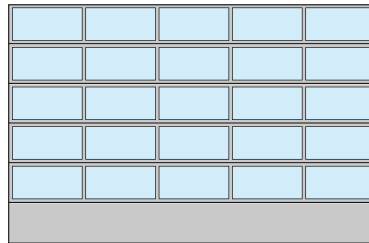

APU F42, APU F42 Thermo,  
APU 67 Thermo  
uniform field division

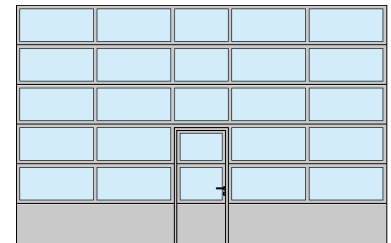

APU F42, APU F42 Thermo,  
APU 67 Thermo  
wicket door in the centre

Clear passage width (LDB)  
APU F42, APU F42 Thermo: 940 mm  
APU 67 Thermo: 905 mm

On request, uniform field division is also possible with wicket door.

The field division of the wicket door arrangement is also available in sectional doors without wicket door.

For modernisation or when the matching appearance of the existing sectional doors must be ensured, the APU F42 / APU F42 Thermo is also available with 91-mm-wide rails.

Colour options page 47  
Glass types page 51  
Safety features in acc. with EN 13241-1, page 57.  
Technical data page 82

# ALR F42, ALR F42 Thermo, ALR 67 Thermo

Glazed aluminium doors



## Commercial buildings

Aluminium profiles with thermal break and optional climatic glazing ensure that insulation is improved by up to 55 %



*Permanent clear view with DURATEC glazing  
for maximum scratch resistance*



**Workshops**

Permanent clear view thanks to standard DURATEC glazing



**Fire station buildings**

Large glazings offer more light in the building



**Collective garages**

Variety of infill options, from expanded mesh to perforated sheet infill for door and wicket door (only ALR F42)

# Glazed aluminium doors



## ALR F42

**1** This door features large glazings down to the bottom sections and a contemporary appearance with aluminium profiles. The DURATEC glazing provides a permanently clear view.

## ALR F42 Thermo

**2** Thanks to the glazing profiles with thermal break and DURATEC synthetic glazing, the door offers excellent transparency and good thermal insulation.

## ALR 67 Thermo // NEW

**3** The ALR 67 Thermo, depth 67 mm, with thermal break glazing beads is recommended for highest thermal insulation requirements.



Door type	ALR F42		ALR F42 Thermo		ALR 67 Thermo	
	without wicket door	with wicket door	without wicket door	with wicket door	without wicket door	with wicket door
<b>Door size</b>						
Max. width (mm)	8000	7000	7000	7000	10000	7000
Max. height (mm)	7500	7500	7500	7500	7500	7500

### Thermal insulation EN 13241-1, Appendix B EN 12428

U-value in W/(m<sup>2</sup>·K) for a door surface 5000 × 5000 mm

Standard double pane	3.6	3.8	3.0	3.2	–	–
With ThermoFrame	3.6	3.8	3.0	3.2	–	–
Standard triple pane	–	–	–	–	2.2	2.4
With ThermoFrame	–	–	–	–	2.1	2.3
Optional climatic double pane, single-pane safety glass	2.7	–	2.1	–	1.7	–
With ThermoFrame	2.6	–	2.0	–	1.6	–

# Up to 55 % improved thermal insulation: ALR 67 Thermo with climatic glazing and ThermoFrame

## The best thermal insulation

For ALR F42 Thermo and ALR 67 Thermo, the aluminium profiles have a thermal break and offer optimum thermal insulation while letting in the maximum of natural light. The ALR 67 Thermo with optional climatic glazing and ThermoFrame decreases the thermal insulation value by approx. 55 % to up to 1.6 W/(m<sup>2</sup>·K), in comparison to an ALR F42.

## Optional infills

We deliver the bottom door section as standard with PU infill and aluminium sheet cover, both sides Stucco-textured. Optionally, the door is available fully glazed without surcharge. Further information about the infill variations is available on page 50.



Bottom door section with PU infill (left) or optionally with glazing (right)

Colour options page 47  
Glass types page 51  
Safety features in acc. with EN 13241-1, page 57.  
Technical data page 82

## Example door versions

Door width up to 4500 mm (example 4500 × 4500 mm)

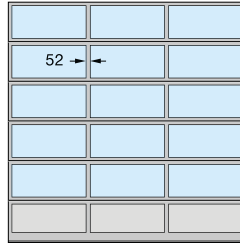

ALR F42, ALR F42 Thermo,  
ALR 67 Thermo  
uniform field division

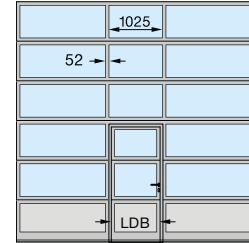

ALR F42, ALR F42 Thermo,  
ALR 67 Thermo  
wicket door in the centre

Door width up to 5500 mm (example 5500 × 4500 mm)

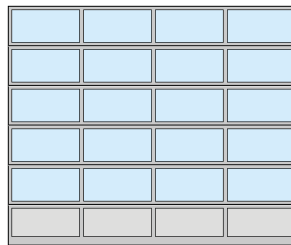

ALR F42, ALR F42 Thermo,  
ALR 67 Thermo  
uniform field division

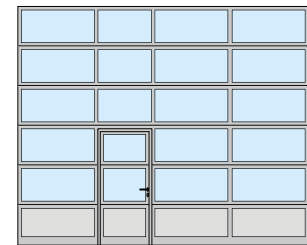

ALR F42, ALR F42 Thermo,  
ALR 67 Thermo  
wicket door to the left

Door width over 5500 mm (example 7000 × 4500 mm)

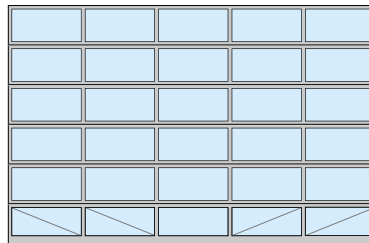

ALR F42, ALR F42 Thermo,  
ALR 67 Thermo  
uniform field division  
fully glazed

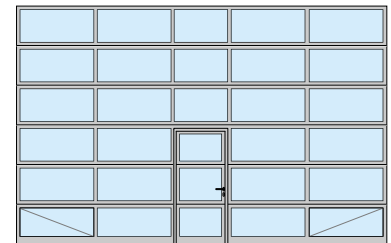

ALR F42, ALR F42 Thermo,  
ALR 67 Thermo  
wicket door in the centre  
fully glazed

Clear passage width (LDB)  
ALR F42, ALR F42 Thermo: 940 mm  
ALR 67 Thermo: 905 mm

On request, uniform field division is also possible with wicket door.

The field division of the wicket door arrangement is also available in doors without wicket door.

For modernisation or when the matching appearance of the existing sectional doors must be ensured, the ALR F42 / ALR F42 Thermo is also available with 91-mm-wide rails.

Individual arrangements of the glass and panel infills or full glazing are possible.

For full glazing from a door width of 5510 mm, the lower window sections are equipped on the inside with diagonal statics cross struts for better stability.

# APU F42 S-Line ALR F42 S-Line

Glazed aluminium doors with invisible section transitions



## Designed facades

Attractive profile design with invisible section transitions (ALR F42 S-Line)



## Car showrooms

Permanent clear view thanks to standard DURATEC glazing (ALR F42 S-Line)



reddot design award  
winner 2010



### Workshops

The PU-foamed bottom section can be replaced easily and inexpensively if damaged, for example, by a vehicle (APU F42 S-Line)

# Glazed aluminium doors with invisible section transitions



## APU F42 S-Line

**1** The combination of narrow glazing beads and a robust bottom section let a lot of light into the building, offering the convincing robustness required for daily use.

## ALR F42 S-Line

**2** The narrow frame structure with invisible section transitions offer a large view. The door can be optimally integrated into modern glass facades, barely distinguishable from fixed glass elements.



Door type	APU F42 S-Line	ALR F42 S-Line
<b>Door size</b>		
Max. width (mm)	5000	5000
Max. height (mm)	7500	7500

### Thermal insulation EN 13241-1, Appendix B EN 12428

U-value in  $W/(m^2 \cdot K)$  for a door surface  $5000 \times 5000$  mm

Standard double pane	3.3	3.5
With ThermoFrame	3.2	3.4
Optional triple pane	2.8	3.0
With ThermoFrame	2.7	2.9

## S-Line The profile with invisible section transitions

The frame construction has a uniform vertical and horizontal width of 65 mm. This also applies to invisible section transitions that, of course, are equipped with seals and finger trap protection.

The profiles appear very delicate thanks to their trapezoidal symmetry. This allows for a harmonious door appearance that can be perfectly integrated into fixed elements of modern glass facades.



Frame construction with seals and finger trap protection

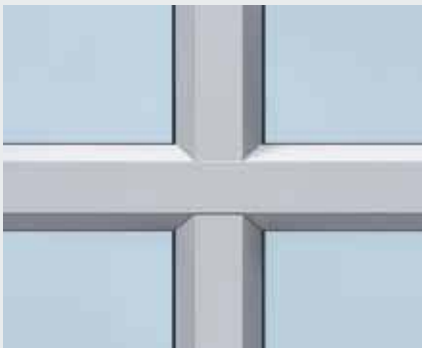

Attractive door appearance due to uniform 65-mm-wide profile view

Colour options page 47  
Glass types page 51  
Safety features in acc. with EN 13241-1, page 57.  
Technical data page 82

## Example door versions

Door width up to 3500 mm (example 3500 × 4500 mm)

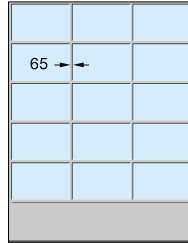

APU F42 S-Line  
uniform field division

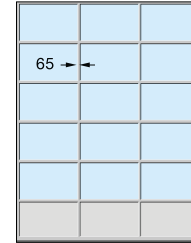

ALR F42 S-Line  
uniform field division

Door width up to 4500 mm (example 4500 × 4500 mm)

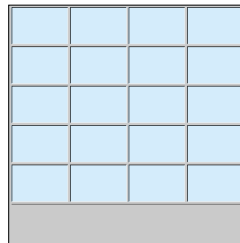

APU F42 S-Line  
uniform field division

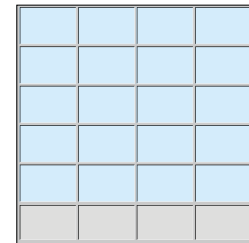

ALR F42 S-Line  
uniform field division

Door width over 4500 mm (example 5000 × 4500 mm)

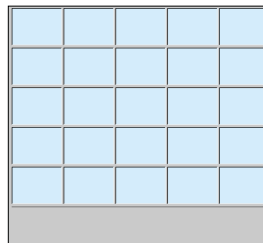

APU F42 S-Line  
uniform field division

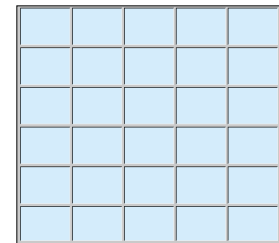

ALR F42 S-Line  
uniform field division  
fully glazed

Wicket doors are not possible with APU F42 S-Line / ALR F42 S-Line doors. Information on matching side doors can be found on page 44.

Individual arrangements of the glass and panel infills or full glazing are possible.

# ALR F42 Glazing, ALR 67 Thermo Glazing ALR F42 Vitraplan

Exclusively glazed aluminium doors



## Car showrooms

Thanks to large glazings made of real glass, the door becomes a display window, attracting potential customers (ALR F42 Glazing)





**ALR F42 Vitraplan**  
**An eye-catcher for prestigious buildings**  
**and modern architecture**



reddot design award  
winner 2010



**Exclusive door appearance**

A clear overall appearance thanks to the offset glazing with a fascinating mix of mirroring and transparency (ALR F42 Vitraplan with matching side doors)



**Designed facades**

Permanent surface protection thanks to standard DURATEC glazing (ALR F42 Vitraplan)

# Exclusively glazed aluminium doors



## ALR F42 Glazing

**1** The window sections, all the exact same height, are produced without vertical rails for door widths of up to 3330 mm. Continuous window sections with real glass offer an unimpeded view into showrooms. The ideal display window door.

## ALR 67 Thermo Glazing

**NEW**

**2** For higher thermal insulation requirements, the ALR 67 Thermo Glazing is available with thermal break profiles, depth 67 mm.

## ALR F42 Vitraplan

**3** The surface-mounted, flush-fitting glazing fascinates with a mix of mirroring and transparency. The colours of the frame profiles are matched to the glazing colours in grey or brown.



Door type	ALR F42 Glazing	ALR 67 Thermo Glazing	ALR F42 Vitraplan
<b>Door size</b>			
Max. width (mm)	5500	5500	6000
Max. height (mm)	4000	4000	7500

### Thermal insulation EN 13241-1, Appendix B EN 12428

U-value in W/(m<sup>2</sup>·K) for a door surface 5000 × 5000 mm

Standard single pane, laminated safety glass	6.1	–	–
Standard double pane, single-pane safety glass	–	3.0	–
With ThermoFrame	–	2.9	–
Standard double pane	–	–	3.2
With ThermoFrame	–	–	3.2
Optional triple pane	–	–	3.1
With ThermoFrame	–	–	3.1
Optional climatic double pane, single-pane safety glass	2.7	1.8	–
With ThermoFrame	2.6	1.7	–

## ALR F42 Vitraplan For sophisticated architecture

The ALR F42 Vitraplan is especially elegant thanks to offset, flush-fitting glazing. The frame profile is concealed, so nothing detracts from the clear overall appearance. Continuous glazing adds an eye-catching element to modern industrial structures and prestigious private buildings.

The door can be harmoniously integrated in the facade with glazings in brown and grey, as well as a dark frame profile colour that harmonises with the glass.



Synthetic pane, grey



Synthetic pane, brown

Colour options page 47  
Glass types page 51  
Safety features in acc. with EN 13241-1, page 57.  
Technical data page 82

### Example door versions

**Door width up to 3330 mm**  
(Example 3300 × 3500 mm)



ALR F42 Glazing, ALR 67 Thermo Glazing

**Door width over 3330 mm**  
(Example 4500 × 3500 mm)

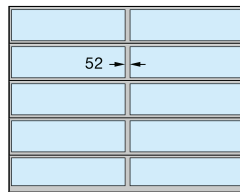

ALR F42 Glazing, ALR 67 Thermo Glazing  
with vertical rail

**Door width over 3330 mm**  
(Example 5500 × 3500 mm)

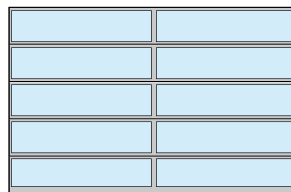

ALR F42 Glazing, ALR 67 Thermo Glazing  
with vertical rail

**Door width up to 4500 mm**  
(Example 4500 × 4500 mm)

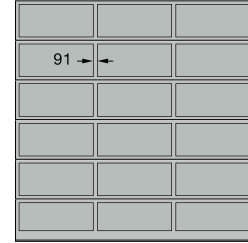

ALR F42 Vitraplan  
uniform field division

**Door width up to 5500 mm**  
(Example 5500 × 4500 mm)

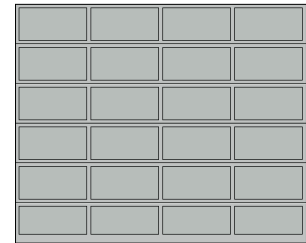

ALR F42 Vitraplan  
uniform field division

**Door width over 5500 mm**  
(Example 6000 × 4500 mm)

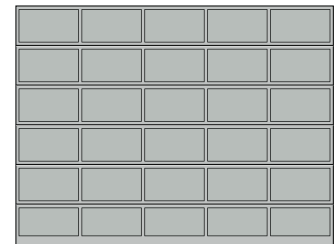

ALR F42 Vitraplan  
uniform field division

For modernisation or when the matching appearance of the existing sectional doors must be ensured, the ALR F42 Glazing is also available with 91-mm-wide rails.

# ALR F42

Aluminium doors for on-site cladding



On-site cladding with aluminium compound board



On-site cladding with timber panels



*For flush-fitting cladding made of timber, metal and many other materials*



**On-site cladding with laminated timber boards**

# Aluminium doors for on-site cladding

## ALR F42

The facade cladding door base consists of frame profiles with PU sandwich infill. The horizontal profiles are cladded. Optionally, we provide vertical fitting profiles to which the facade material can be attached simply and unseen.

You can design the on-site, flush-fitting facade cladding according to your wishes with timber, metal, ceramic, plastic and many other materials. Please observe the maximum weight per unit area of the on-site cladding. For further information, see the planning aid.



<b>Door type</b>	<b>ALR F42</b>
<b>Door size</b>	depending on weight of on-site cladding
Max. width (mm)	7000
Max. height (mm)	4500
<b>Thermal insulation EN 13241-1, Appendix B EN 12428</b>	
U-value in $W/(m^2 \cdot K)$ for a door surface $5000 \times 5000$ mm	
PU sandwich infill	2.6

## Excerpt from the planning aid

Standard fitting in the opening

### Standard version

#### 1 Horizontal view

Door frame connection to the facade wall

#### 2 Vertical view

Section transitions

### Version with fitting profiles (red)

#### 3 Horizontal view

Door frame connection to the facade wall

#### 4 Vertical view

Section transitions

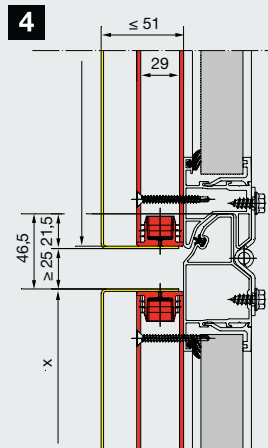
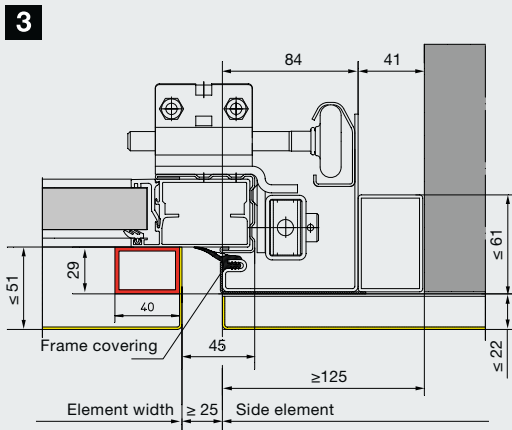
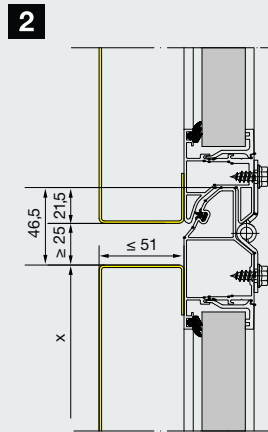
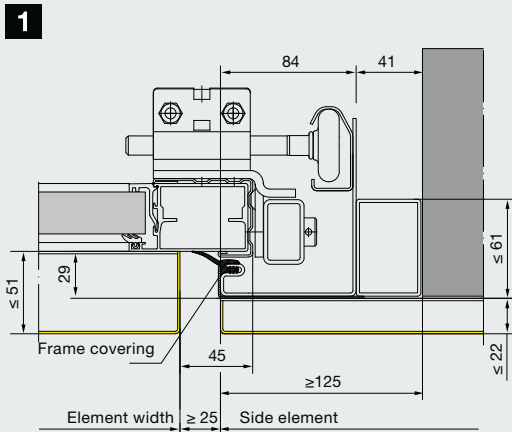

## Example door versions

### Door width up to 4500 mm

(Example 4500 × 4500 mm)

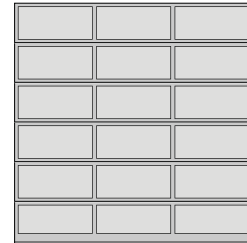

ALR F42  
uniform field division

### Door width up to 5500 mm

(Example 5500 × 4500 mm)

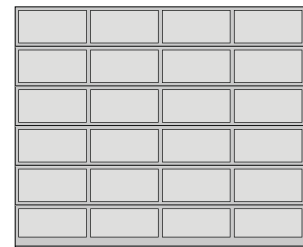

ALR F42  
uniform field division

### Door width over 5500 mm

(Example 7000 × 4500 mm)

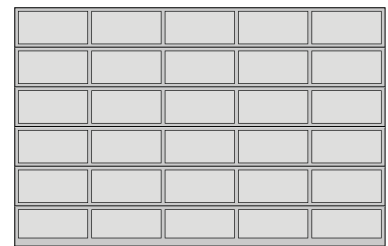

ALR F42  
uniform field division

For detailed planning documents, please visit  
[http://www.hoermann.de/fileadmin/dokumentationen/anleitungen/garagen-sectionaltore/Fassadentor\\_Planungshilfen.pdf](http://www.hoermann.de/fileadmin/dokumentationen/anleitungen/garagen-sectionaltore/Fassadentor_Planungshilfen.pdf)

Colour options page 47

Glass types page 51

Safety features in acc. with EN 13241-1, page 57.

Technical data page 82

# Wicket doors with trip-free threshold

As a fully-fledged escape route



## Trip-free passage

Wicket doors with trip-free thresholds pose less of a risk for persons stumbling and injuring themselves. Tool cars or trolleys can easily pass over the very flat stainless steel threshold with rounded edges.

The wicket door with trip-free threshold has many benefits:

- The garage door does not need to be opened for pedestrian traffic.
- It reduces the risk of tripping up and makes it easier to wheel things through.
- Power-driven doors feature a leading photocell VL 2 with two sensors which causes the door to reverse on encountering an obstruction well before contact is made.
- The wicket door contact ensures that the main door can only be opened when the wicket door is closed.



Take a look at the video at:  
[www.hoermann.com](http://www.hoermann.com)







**World's first  
Wicket door construction  
with thermal break, 67 mm depth**



**Wicket door construction  
in sectional doors  
with 42 mm depth**

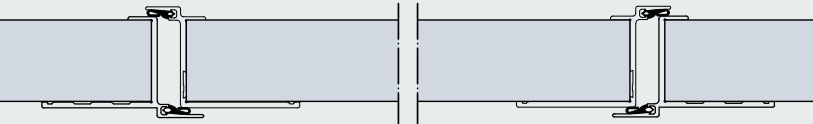

**Wicket door construction  
with thermal break in sectional doors  
with 67 mm depth**

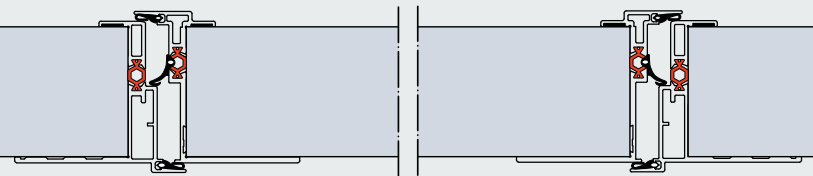

**Avoid accidents**

The wicket door with trip-free threshold is provided with a stainless-steel threshold rail that is 10 mm flat in the middle and 5 mm at the edges. For doors with widths from 5510 mm, the threshold is approx. 13 mm.

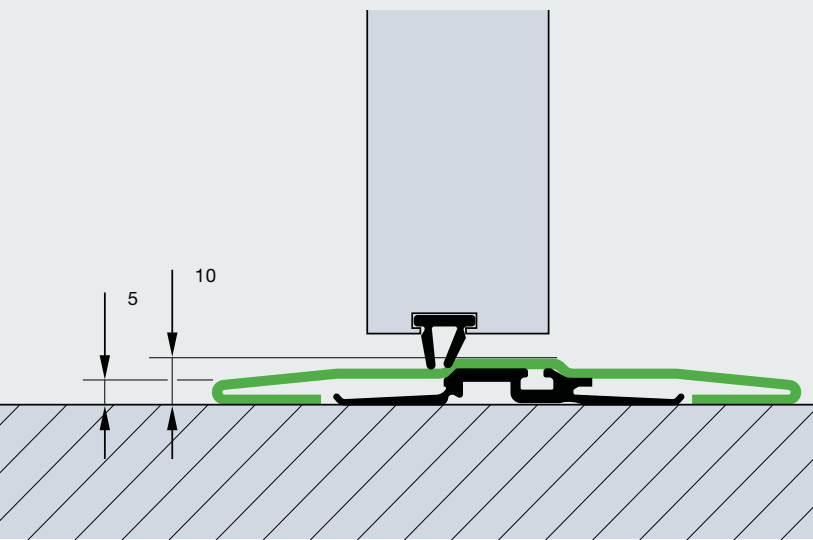

**905 / 940 mm clear passage width  
as standard**

Under certain circumstances, the wicket door with trip-free threshold, with its clear passage width of 905 mm (depth 67 mm) or 940 mm (depth 42 mm), fulfils the requirements of an escape door and for barrier-free construction.

**As an escape door**

Up to a door width of 5500 mm, Hörmann sectional doors with a wicket door with trip-free threshold fulfil the requirements of an escape door under certain circumstances.

**As an unobstructed entrance**

Under certain conditions, Hörmann sectional doors with a wicket door with trip-free threshold fulfil the requirements for accessibility in accordance with DIN EN 18040-1 and are certified by the IFT Rosenheim.

**Freely selectable position**

The wicket door can be positioned both to the left, right and centre (except in the two outermost fields). The window sections above the wicket door have a clear view of 1025 mm as standard. All the door's additional fields have the same width.

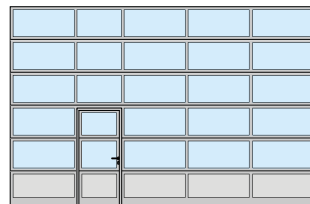

Wicket door to the left

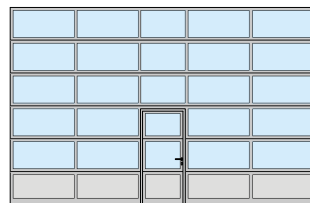

Wicket door in the centre

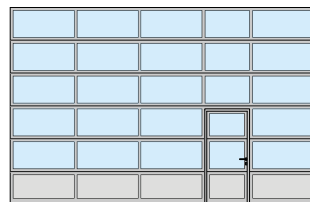

Wicket door to the right

On request, doors with wicket door are also available with uniform field division and the wicket doors can be supplied in individual sizes or matching to existing doors, even with threshold rails. We recommend the wicket door with threshold rail for inclining surfaces in the opening area.

# Wicket doors with trip-free threshold

With high-quality equipment

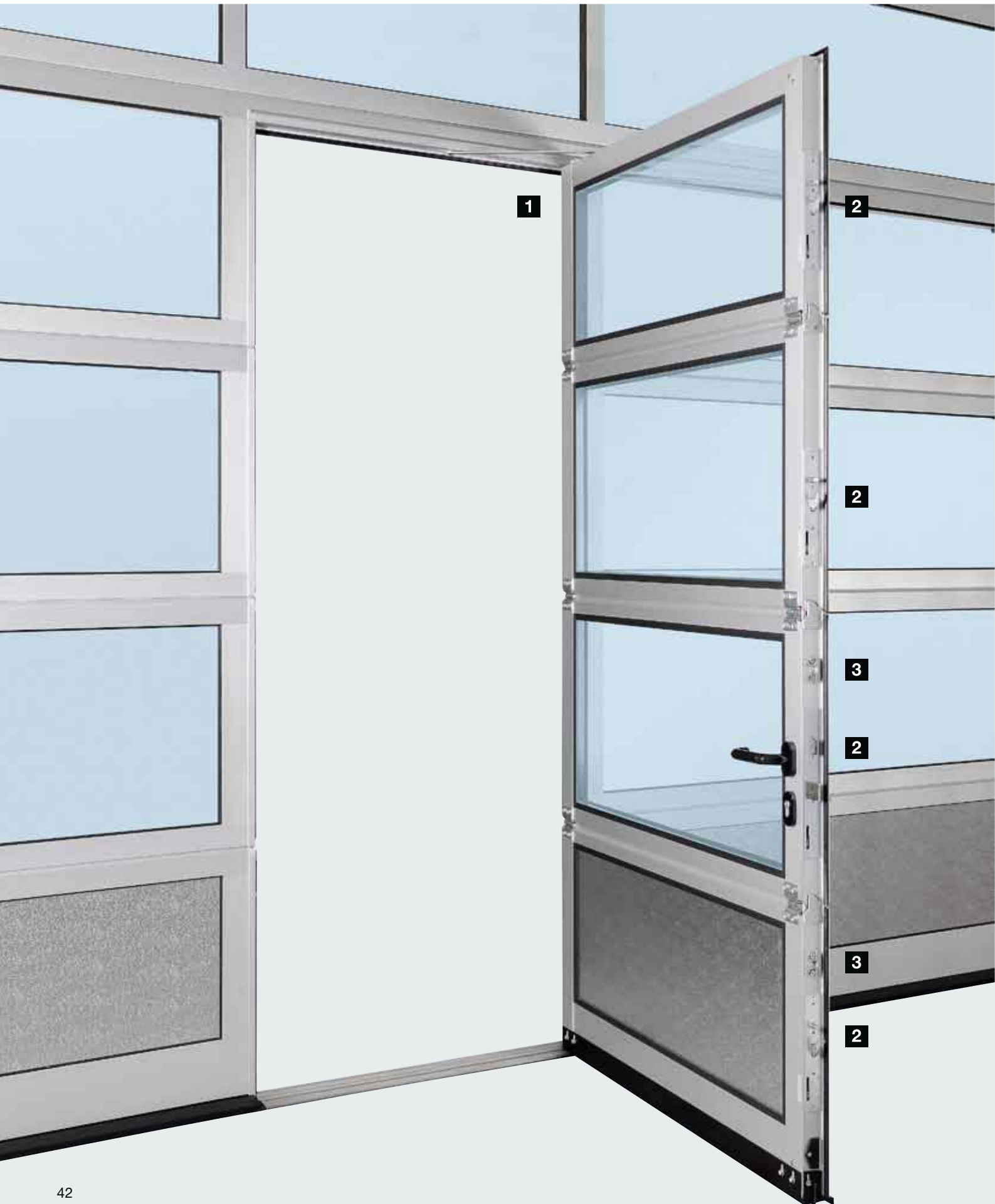



**Overhead door closer**

As standard, wicket doors are supplied with slide rail door closers (top figure). An integrated door closer, including hold-open device (bottom figure), is optionally available for optimum protection and the best appearance (except for depth 67 mm).



**Optional multiple-point locking**

The wicket door is locked over the entire door height with one bolt and hook bolt per section. The advantage: better stability and improved break-in-resistance (except for depth 67 mm).



**Robust door catch**

This prevents door-leaf drop and buckling.



**Flat wicket door frame**  
The all-round frame consists of a flat aluminium profile, harmoniously integrating the wicket door into the door.



**Concealed hinges**  
For a uniform look, the wicket doors are equipped with concealed hinges as standard.



**Finger trap protection**  
standard on the interior and exterior of wicket door frames (except for wicket door with depth 67 mm)



**Optimally sealed**  
The adjustable threshold profile with flexible seal compensates for unevenness in the floor.

Adjustable double seals located in the transition from the bottom edge of the door to the floor and the door leaf to the threshold optimally seal the bottom edge of the door and the wicket door opening.

**Only Hörmann wicket doors with trip-free thresholds can be used without restriction in automatic operation thanks to the leading photocell VL 2**

## Side doors

Matching the door or with a door leaf with thermal break



## Aluminium side doors matching the door

If sufficient space is available next to the door, the matching side door provides a safe way of separating employee traffic from vehicle traffic. For your safety, side doors also serve as escape routes. They open inwards and outwards and can be right or left-hand hinged. Side doors are also available on request with 3-point locking (latch, bolt, double locking hook and security rose escutcheon).

### Side door equipment

- Aluminium extrusions anodised according to DIN 17611, 60 mm, surface anodised in natural colour E6 / C0 (previously E6 / EV 1)
- As standard with all-round seals made of long-lasting, weather-resistant EPDM
- Infill variations the same as for sectional doors with 42 mm depth

### Fittings

- Mortice lock with profile cylinder
- Offset lever handle set with oval rose escutcheon, made of black plastic
- On request also available as lever/knob handle sets
- Optionally available in natural finish cast aluminium, polished stainless steel or brushed stainless steel

### Overhead door closer

- Optional with side doors



## Steel side doors with door leaf with thermal break and high thermal insulation

### MZ Thermo multi-purpose door (right)

- 46-mm-thick door leaf with thermal break and PU rigid foam infill
- Aluminium block frame with thermal break and threshold with thermal break
- High thermal insulation with a U-value = 1.2 W/(m<sup>2</sup>·K)
- Optionally available in a WK 2 KSI Thermo version

Additional information can be found in the Function doors for construction projects brochure.



## Greater freedom to design with individual colour schemes



SPU F42 in Moss green, RAL 6005



Doors with double-skinned steel sections in any of the 10 preferred colours are supplied in Grey white, RAL 9002, on the inside (SPU F42 shown).



APU F42 in Grey aluminium, RAL 9007



Door leaf reinforcements\*\* and the end caps of the sections on the inside of coloured doors are supplied in Grey white, RAL 9002, as standard. With doors with wicket doors, the frame of the wicket door on the inside consists of aluminium profiles in E6 / C0 (previously E6 / EV 1).

**Colours are increasingly being used to fly the company flag. In this regard, coloured industrial doors are an ideal vehicle.**

The primer-coating of all industrial doors from Hörmann is available in 10 preferred colours, as well as RAL and NCS, in many metallic colours as well as acc. to British Standard.\*



The 2K-PUR coating on the exterior or on the exterior and interior sides and the coil coating procedure for double-skinned sections in preferred colours ensures high-quality, long-lasting colour. This maintains the attractive appearance of your door.

Dark colours should not be used for double-skinned steel doors and for doors with thermal break that are exposed to the sun, as possible section deflection may restrict the door's function (bi-metal effect).

The galvanized subframe and fittings are not factory-coated. Anodised profiles for the wicket door and glazing beads can be optionally coated. The frames for compound windows are black as standard. Door leaf reinforcements\*\* and end caps are Grey white, RAL 9002, as standard.

The colours shown are subject to the limitations of the printing process and cannot be regarded as binding. Contact your Hörmann specialist dealer for advice regarding coloured doors. All colours based on RAL.

\* With the exception of pearl-effect and fluorescent colours. Slight colour variations are permissible.

\*\* Except for ALR F42 Vitraplan

**10 preferred colours  
for depth 42 mm**

	Traffic white	RAL 9016
	Pure white	RAL 9010
	Grey aluminium	RAL 9007
	White aluminium	RAL 9006
	Grey white	RAL 9002
	Terra brown	RAL 8028
	Anthracite grey	RAL 7016
	Moss green	RAL 6005
	Gentian blue	RAL 5010
	Flame red	RAL 3000

**2 preferred colours  
for depth 67 mm**

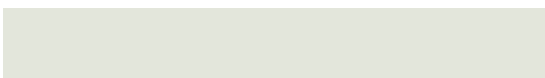
	White aluminium	RAL 9006
	Grey white	RAL 9002

# Maximum scratch resistance with Hörmann's sectional door glazing



## A permanently clear view

The new DURATEC glazing is available as standard and at no extra charge in all sectional doors with synthetic glazing – only from Hörmann.

With DURATEC synthetic glazing, Hörmann sectional doors retain their clear view permanently, even after multiple cleanings and heavy use.

## Better protection against scratches caused by cleaning

A special surface coating, similar to that used on car headlights, protects the pane over the long-term from scratches and damage caused by cleaning.



Take a look at the video at:  
[www.hoermann.com](http://www.hoermann.com)



DURATEC synthetic glazing  
with maximum scratch resistance



Sensitive, common synthetic glazing



# Excellent thermal insulation as standard

## Conventional double pane, 16 mm from other manufacturers

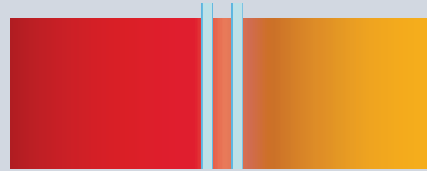

## DURATEC double pane, 26 mm

Compared with conventional 16 mm glazing, the standard 26 mm double pane improves thermal insulation by up to **20 %**.

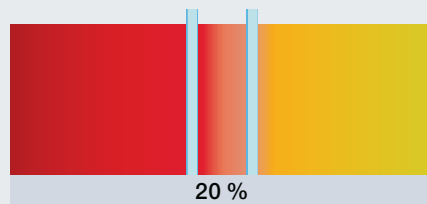

## DURATEC triple pane, 26 mm

The optional triple glazing increases the effective thermal insulation by up to **35 %** in comparison to conventional 16-mm-thick glazing.

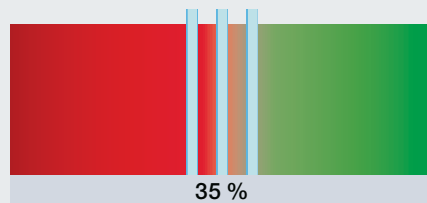

## DURATEC triple pane, 51 mm

Thermal insulation is improved by up to **40 %** thanks to the optional triple glazing with a pane thickness of 51 mm, compared to a 16-mm-thick glazing.

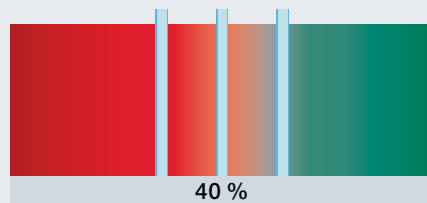

## DURATEC quadruple pane, 51 mm

In comparison to 16-mm glazing, the optional quadruple glazing increases the effective thermal insulation by up to **55 %**.

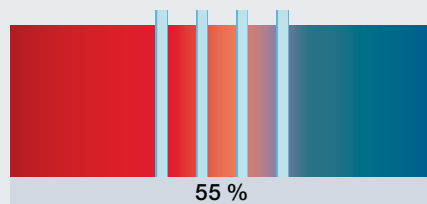

## Climatic double pane, 26 mm

Using this type of pane helps to minimise heat transmission. The improvement in thermal insulation is approx. **65 %**.

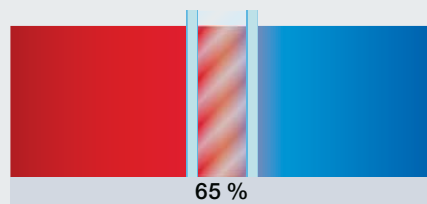

Interior side

Exterior side

# Glazings, infills



● = Possible

DURATEC	SPU F42	SPU 67 Thermo	APU F42	APU F42 Thermo	APU 67 Thermo	ALR F42	ALR F42 Thermo	ALR 67 Thermo	APU F42 S-Line	ALR F42 S-Line	ALR F42 Glazing	ALR 67 Thermo Glazing	ALR F42 Vitraplan
---------	---------	---------------	---------	----------------	---------------	---------	----------------	---------------	----------------	----------------	-----------------	-----------------------	-------------------

## Aluminium glazing frame

### Synthetic panes

Clear single pane	●	●		●			●						
Single pane, crystal structure		●		●			●						
Clear double pane	●	●		●	●		●	●		●	●		●
Double pane, crystal structure	●	●		●	●		●	●		●	●		●
Double pane, tinted brown, grey or white (opal)	●	●		●	●		●	●		●	●		●
Clear triple pane	●	●	●	●	●	●	●	●	●	●	●		●
Triple pane, crystal structure	●	●	●	●	●	●	●	●	●	●	●		●
Triple pane, tinted in brown, grey or white (opal)	●	●	●	●	●	●	●	●	●	●	●		●
Clear quadruple pane	●		●			●		●					
Quadruple pane, crystal structure	●		●			●		●					
Quadruple pane, tinted in brown, grey or white (opal)	●		●			●		●					

### Polycarbonate panes

Clear single pane	●	●		●			●						
Clear double pane	●	●		●	●		●	●		●	●		●

### Real glass panes

Clear single pane made of laminated safety glass		●		●			●					●	
Clear double pane, single pane safety glass		●	●	●	●	●	●	●	●			●	●
Clear climatic double pane, single pane safety glass		●	●	●	●	●	●	●	●			●	●

### Infills

Multiple-moulded pane (7 x)		●		●	●		●	●					
Expanded mesh, stainless steel Ventilation cross section: 58 % of the infill surface		●		●			●						
Perforated steel sheet, stainless steel Ventilation cross section: 40 % of the infill surface		●		●			●						
PU infill Aluminium sheet cladding, anodised on both sides, smooth				●	●	●	●	●	●	●			
PU infill Aluminium sheet cladding, Stucco-textured both sides				●	●	●	●	●	●	●			

## Compound glazings

### Synthetic panes

Clear double pane, synthetic frame	●	A,D,E	D										
Clear double pane, diecast frame	●	A	A										
Clear triple pane, synthetic pane	●		D										
Clear triple pane, diecast frame	●		A										
Clear quadruple pane, diecast frame	●		A										

### Polycarbonate panes

Clear double pane, diecast frame	●	A											
----------------------------------	---	---	--	--	--	--	--	--	--	--	--	--	--

## Aluminium glazing frame



Standard profile/Thermo profile



S-Line profile

### Standard profile / Thermo profile

**Glazing frame:**

Anodised E6 / C0 (previously E6 / EV 1) with / without thermal break

**Clear view:**

depending on version

**Rail extrusion:**

52 mm, optional 91 mm (only for depth 42 mm)

### S-Line profile

**Glazing frame:**

Anodised E6 / C0 (previously E6 / EV 1)

**Clear view:**

depending on version

**Rail extrusion:**

65 mm

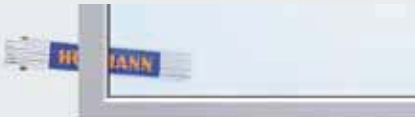

Synthetic pane, clear



Synthetic pane, crystal structure



Synthetic pane, grey



Synthetic pane, brown



Synthetic pane, white (opal)

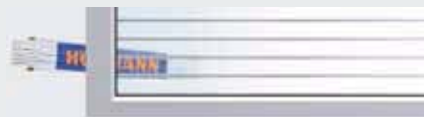

Multiple-moulded pane



Expanded mesh



Perforated steel sheet



PU sandwich infill, smooth



PU sandwich infill, Stucco

## Compound glazings



Type A



Type D

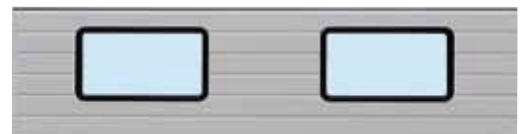

Type E

### Type A

**Glazing frame:**

Plastic frame or diecast frame, black

**Clear view:**

635 × 245 mm

**Door section height:**

500, 625, 750 mm

### Type D

**Glazing frame:**

Plastic frame, black

**Clear view:**

602 × 132 mm

**Door section height:**

500, 625, 750 mm

### Type E

**Glazing frame:**

Black plastic frame

**Clear view:**

725 × 370 mm

**Door section height:**

625, 750 mm

# Efficient thermal insulation

With a thermal break between frame and brickwork

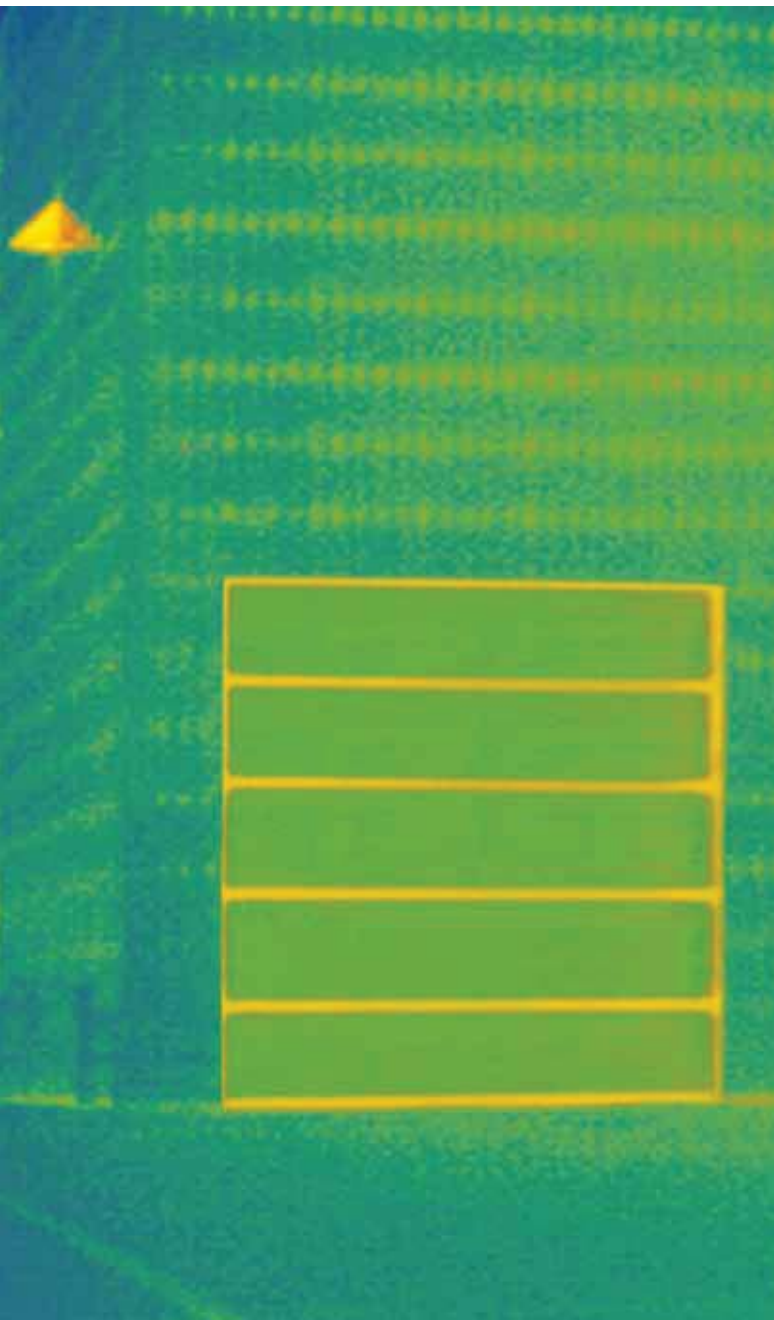

Good thermal insulation for SPU 42 Thermo

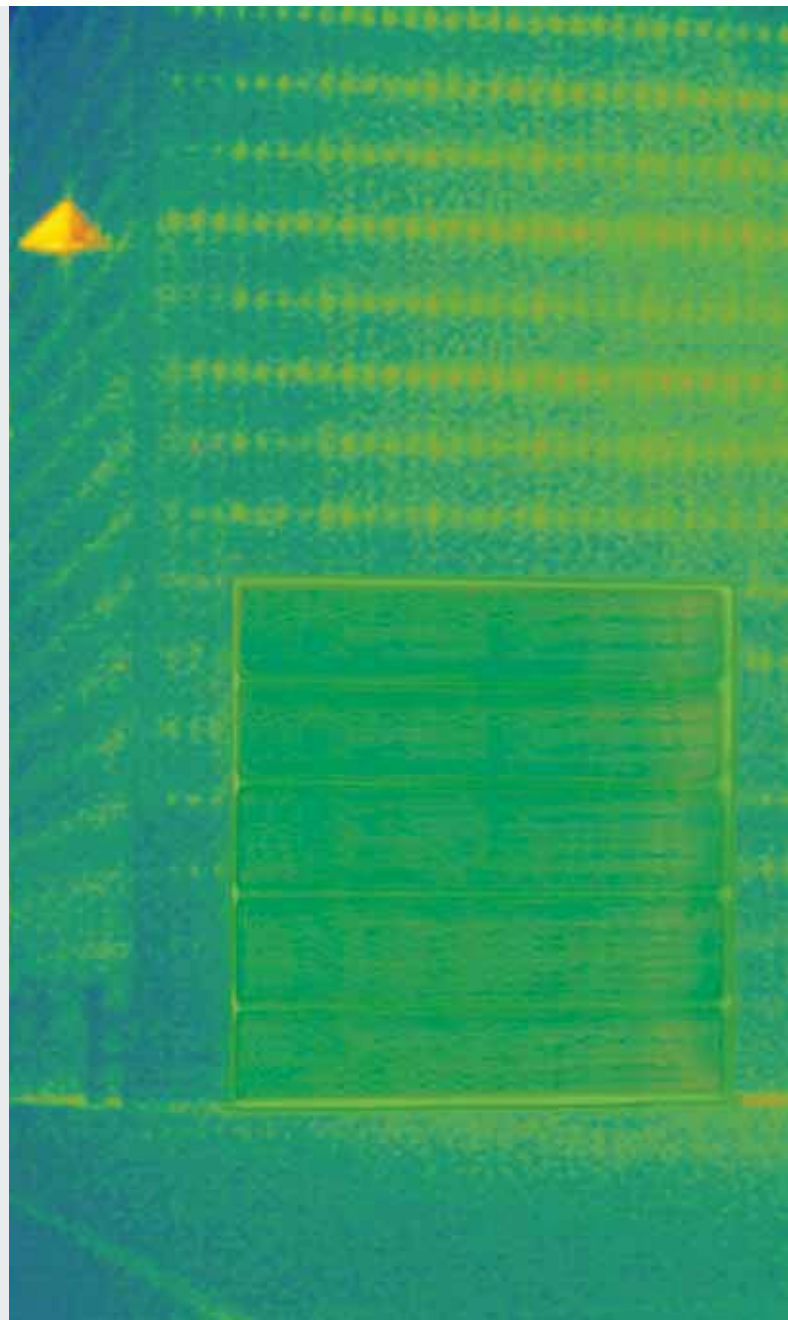

Optimum thermal insulation with the SPU 67 Thermo

## ThermoFrame

Well-insulated doors are essential in heated buildings.

This is why Hörmann industrial sectional doors come, optionally, with a ThermoFrame frame connection with a thermal break between the frame and brickwork.

The lip seals on both sides of the door and in the upper section of the door offer additional insulation, increasing it by up to 21 %.

PATENT PENDING

**Only from Hörmann**

### ThermoFrame optionally available for all industrial sectional doors

- Thermal break between the frame and brickwork
- Additional seals for improved tightness
- Easy to fit along with the door frame
- Optimum corrosion-protection of the side frame
- **Up to 21 % better thermal insulation** in the SPU 67 industrial sectional door with a door surface of 3000 × 3000 mm

Up to **21%** better thermal insulation

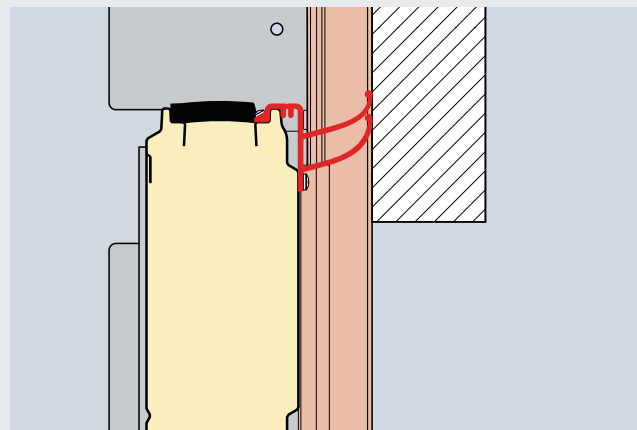

Lintel fitting with ThermoFrame

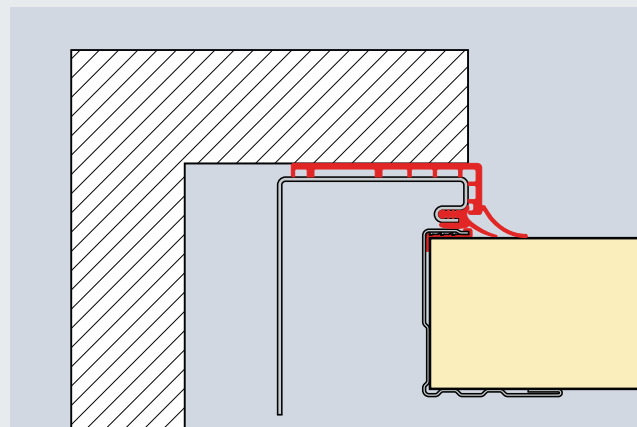

Sideroom with ThermoFrame

SPU F42 Door surface (mm)	Without ThermoFrame W/(m <sup>2</sup> ·K)	With ThermoFrame W/(m <sup>2</sup> ·K)	Improvement %
3000 × 3000	1.22	1.07	12.3
4000 × 4000	1.10	0.99	10.0
5000 × 5000	1.03	0.94	8.7
<b>SPU 67 Thermo</b> Door surface (mm)			
3000 × 3000	0.81	0.64	21.0
4000 × 4000	0.69	0.56	18.8
5000 × 5000	0.62	0.51	17.7

## Examples of track versions

### Sound planning for old and new buildings



### **Track applications that fit precisely to the building**

Whichever door type you have selected for your building: At Hörmann, you will find the a track application to match your door. Depending on the building architecture and requirement, you can choose between standard and low headroom track applications, low headroom track applications or inclined track applications.

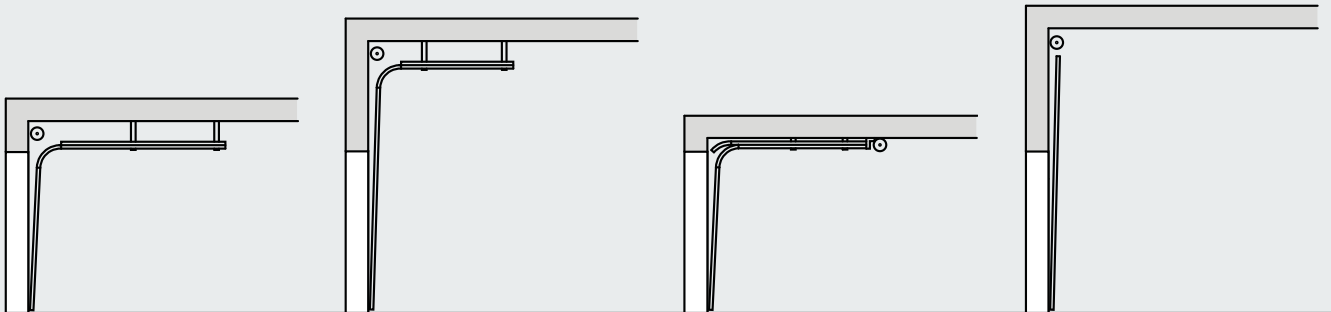

Track application N  
Normal track application

Track application H  
High-lift track application

Track application L\*  
Low headroom track application

Track application V  
Vertical track application

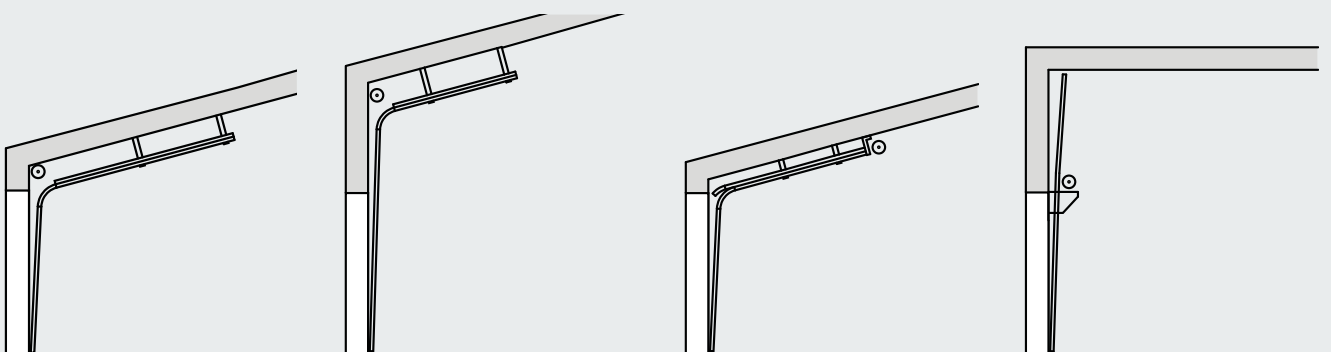

Track application ND\*  
With inclination

Track application HD\*  
With inclination

Track application LD\*  
With inclination

Track application VU  
With low-mounted  
spring shaft

Please see the valid technical manual  
for all of the available track applications.

\* Not for sectional door  
with 67 mm depth



### The low headroom track application

Operator and chain are directly on the door.  
An unsightly and potentially hazardous chain  
no longer dangles down. It pays to compare!

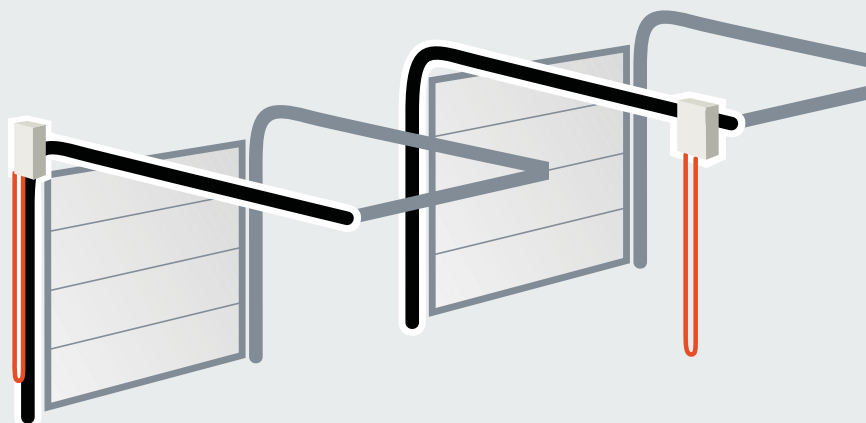

Hörmann's optimal arrangement

Competitors' arrangement

# The best proof of quality: Advanced technology in every detail

## 1 Quiet door travel

Hinged roller holders made of galvanized steel with adjustable plastic rollers on ball-bearings ensure precise, quiet door travel.

## Particularly service-friendly

If the frame is damaged in a collision, the **bolted tracks** can be exchanged easily and inexpensively.

## 2 Galvanized, articulated roller holder

The articulated roller holder reduces the headroom and protects the top door section from excessive bending when the door is open.

## 3 Strong-holding connections

Stable centre hinges made of galvanized steel connect the individual door sections precisely. Edge profiling of the door sections has been designed so that the screws are held by multiple layers of sheet and are resistant to tearing out.

## 4 Upper frame end with connecting bracket

Permanently defined positions for the spring shaft bracket make it easier to fit the entire spring shaft.

## Connection of spring shaft to cable drum

A separate feather key is not required; instead, a secure diecast connection increases functional safety and is easy to fit.

The shaft is galvanized, **the springs are shot-blasted and coated.**

## Flexible shaft coupling

Low variation in the axial alignment can be compensated by the flexible shaft coupling.

## 5 Pre-fabricated suspension

Ceiling suspension of the tracks is achieved through special anchors with slotted holes, made of galvanized steel. They are pre-fabricated as much as possible for the respective fitting situation.



SPU F42 shown



# Safety features in accordance with European standard 13241-1



Doors must comply with the safety requirements of European standard 13241-1.

Have this confirmed by other manufacturers!

## Hörmann products are tested and certified for:

### Anti-fall safeguard

#### 6 Reliable door guidance

The rollers are guided precisely in a **safety track** developed by Hörmann. This is why the door leaf cannot fall out during the turning phase or when parked near the ceiling.

#### 7 Optimum counterbalance

The torsion spring assembly with grooved spring shaft ensures an optimum counterbalance. As a result, the door moves easily during the entire opening and closing phase.

#### 8 Catch safety device (depending on equipment)

This load-dependent latch device is integrated in the load carrier for protection in case a cable or spring breaks.

**European patent**

#### 9 Spring safety device (depending on equipment)

Stops the torsion spring shaft if a spring breaks and securely holds the door in this position. **European patent**

### Trap protection

#### 10 Finger trap protection

The unique form of the door sections eliminates trap points on doors with a depth of 42 mm, both on the outside and inside.

#### 11 Internally guided cables

The carrying cables are guided on the inside between the door leaf and frame. No protruding components. This virtually excludes the risk of injuries. For doors with a low headroom track application, the load carrier consists of a carrying chain / carrying cable.

#### 12 Side trap guards

The side frames are completely closed from top to bottom. This creates a secure side trap guard.

#### 13 Closing edge safety device

Sensors monitor the bottom edge of the door and stop and reverse it if there is a hazard. A leading photocell ensures particularly safe monitoring of the closing edge (for further information, see page 62). Obstructions are detected before they come into contact with the door.

# Manually operated doors

As standard with pull rope or pull rod

## Optional operation options

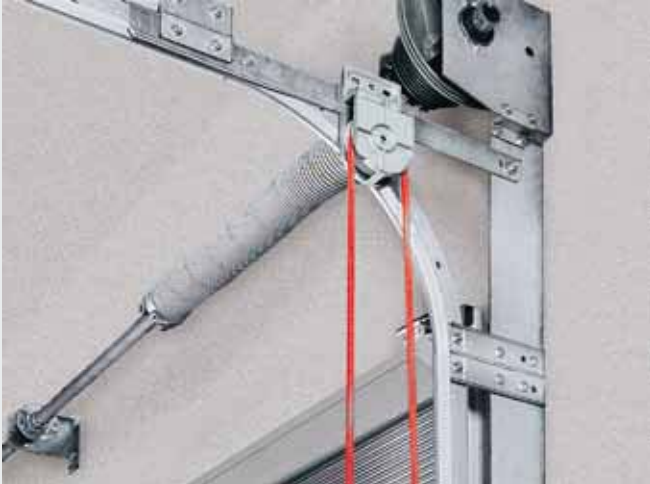

Optional: Hand pulley with rope or link steel chain



Optional: Chain hoist



Optional: Chain tensioner for easier operation

## Securely locked as standard



### Shootbolt

This can be secured with an on-site padlock as a secure night lock.

### Only from Hörmann



### Rotary latch

This door lock automatically locks itself through the latching disc. On request, doors with VU and HU tracks (with spring shaft at bottom) are available.

### Only from Hörmann



EUROPEAN PATENT

### Floor locking

This enables frequently used doors to be released by foot. The automatic latch audibly engages when closed.

# The door handle

## Standard security



### Lock operation from outside

With the handle set, the door lock can be ergonomically operated from outside. From inside, the lock is operated via T-handle and locking pin.

**The profile cylinder can also be integrated into central locking systems.**



Shootbolt



Rotary latch



### Recessed handle set

Vertical door guidance, ideal for logistics applications, thanks to a flat design and flexible installation height (dock doors). You can operate two functions with the locking cylinder: **permanently unlocked door and automatic re-locking.**

All parts on the inside are protected by cladding.



Shootbolt



Rotary latch

# Compatible system solutions

For high functional safety of the door



Convenient combined control unit with BiSecur radio technology



Perfect interplay of door, operator and loading technology



Simple installation thanks to system components

## Hörmann Operators and Controls

Hörmann has developed its own operators and controls. This means the components have been adjusted to work together, ensuring the door's functional safety.

The uniform operating concept and the 7-segment displays facilitate daily use. Fitting is also simplified thanks to uniform housing and cable sets. This is how all Hörmann products are designed to work efficiently and for simple connection to other Hörmann products as follows:

- Industrial doors
- Loading technology
- Operators
- Controls
- Accessories

Further information about the operators, controls and accessories can be found on pages 66–81.

# Leading photocell VL 1

Optional for all power-driven sectional doors

**NEW**  
**No surcharge**



## Increased safety

Thanks to the non-contact automatic safety cut-out, persons and obstacles are quickly recognised without door contact. The door stops before contact and immediately travels backwards, virtually excluding the risk of damage or injury.

## Faster door action

The leading photocell can close the door at a speed of up to 30 cm/s, reducing your energy costs due to shortened door opening times.

## Lower inspection and maintenance costs

Industrial doors with non-contact door monitoring that have been approved for person safety purposes do not need to have their closing force approved. This means you save the extra costs for the additional inspection in accordance with ASR A1.7.

## Closing edge safety device with optosensors or with leading photocell

All power-driven Hörmann industrial sectional doors with WA 400 and ITO 400 operators are equipped with a self-monitoring closing edge safety device with optosensors as standard. You can also select the leading photocell VL 1 for non-contact door monitoring of the closing edge without a surcharge. This solution offers you increased safety, faster door action and lower inspection and maintenance costs.

**The non-contact, automatic safety cut-out protects people and property**



Leading photocell VL 1



Leading photocell VL 2



The anti-crash protection at the sides prevents the swivel arm from being damaged when the door is closed.



## Leading photocells

Using the leading photocells VL 1 and VL 2 means increasing the safety of Hörmann industrial sectional doors. The sensors monitor the bottom edge of the sectional door. Obstacles or persons are quickly recognised and the sectional door reverses before contact is made. Another benefit is the faster door travel speed.

# Light grille

## Integrated into the frame

**NEW**



### Light grille HLG // **NEW**

The light grille integrated into the frame recognises persons and obstacles without making contact, virtually excluding the risk of damage or injury.

**A closing edge safety device with optosensors or additional photocells is not required.** Fitting the light grille in the frame means exceptional protecting against damage or accidental misadjustment.

#### For controls

**A / B 445, A / B 460, B 460 FU**

Not approved for sectional doors with wicket door with trip-free threshold.

- **Maximum safety**  
Persons and obstacles are effectively recognised thanks to the cross-beam sensors.
- **Increased personal protection**  
Up to a height of 500 mm the sensors are arranged with an especially tight spacing.
- **Improved energy efficiency**  
The door can be shut at a speed of up to 50 cm/s (with operator WA 400 FU and control 460 FU, depending on track application and size).
- **Protection against damage**  
The light grille is integrated in the frame for optimum protection.
- **Simple installation**  
The mounting brackets securely fasten the light grille with optimum alignment in the frame (patent pending).
- **Can be retrofitted**  
Existing doors with closing edge safety device with optosensors can be easily retrofitted with the HLG light grille.
- **Lower inspection and maintenance costs**  
Inspection of the closing force in accordance with BS EN 13241-1:2003, section 4.4.3 is not necessary.



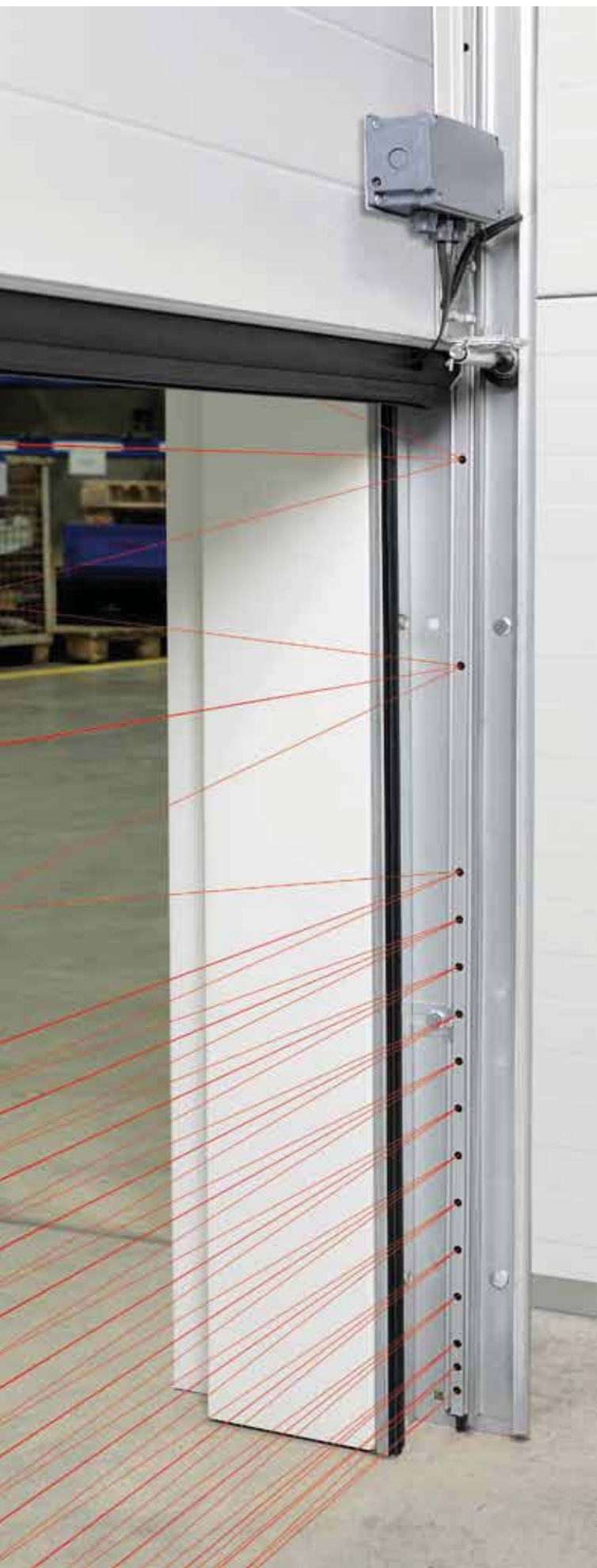

## Other photocells and light grilles



### Photocell RL 50 / RL 300

Reflection photocell with transmitter / receiver unit and reflector.  
The photocell is tested by the control prior to each closing cycle.  
Connected via a system cable (RL 50, length 2 m) or a 2-wire cable (RL 300, length 10 m).  
Max. range 6 m  
Dimensions: 68 × 97 × 33 mm (W × H × D)  
Reflector: 30 × 60 mm (W × H)  
Protection category: IP 65



### One-way photocell EL 51

Photocell with separate transmitter and receiver.  
The photocell is tested by the control prior to each closing cycle.  
Connected via a system cable  
Max. range 8 m,  
Dimensions with fitting bracket: 60 × 165 × 43 mm (W × H × D)  
Protection category: IP 65



### Light grille ELG

The light grille monitors the entire closing zone of the door up to a height of 2500 mm.  
The ELG 1 light grille can be easily integrated in the STL post set made of weather-resistant anodised aluminium.

Voltage supply: 24 V DC,  
Power consumption: 100 mA each,  
Range: 0 to 12 m,  
Protection category: IP 65  
Sun suppression: 150,000 lux,  
Operating temperature: -25 °C to +55 °C,  
Resolution: 60 mm crossed,  
Light source: LED infrared,  
Transmitter lead length: 10 m,  
Receiver lead length: 5 m,  
Height: ELG 1 = 1380 mm, ELG 2 = 2460 mm

# Shaft operator WA 300 S4

## With standard soft start and soft stop



### Soft start / stop

For gentle and quiet door travel, thereby sustainably increasing the service life of the door system.



### Lower investments, lower consumption

The WA 300 S4 costs approx. 30 % less than a 3-phase current operator, and daily power consumption is reduced by up to 75 %.



### Simple, fast fitting and start-up

since many components have already been pre-assembled and no closing edge safety devices or cable slack switches have to be fitted.

For further information, please see the fitting data or contact your Hörmann partner.

## Advantages at a glance

### Particularly easy to fit and maintain thanks to its power limit as standard

For doors without wicket doors, installing items such as closing edge safety devices or cable slack switches on the door is not required. This reduces costs and the risk of repair and services.

### Safe "Close" travel with reduced speed

All "Open" travel as well as "Close" travel above a 2500 mm opening height takes place at a speed of approx. 19 cm/s. With an opening height below 2500 mm, "Close" travel must be set to approx. 10 cm/s for safety reasons. This restriction does not apply to optional leading photocells or closing edge safety devices, meaning the door opens and closes at approx. 19 cm/s.

### Integrated control with push button

DTH R Operator WA 300 S4 can also optionally be supplied with external control 360 (prepared for traffic control).

### Door sizes

Max. door width 6000 mm Max. door height 4500 mm

### For max. 150 door cycles per day

or up to 100 parking spaces in collective garages



Diagonal fitting variant



Vertical fitting variant

## As standard with WA 300 S4

- **Soft start and soft stop for gentle and quiet door travel**
- **Power limit in “Open” / “Close” directions**
- **Integrated control with push button DTH R**
- **Small side room of only 200 mm**
- **No installations or cabling required on the door\***
- **No cable slack switch required**
- **Only approx. 1 watt power consumption in stand-by mode (if no other electrical accessories are connected)**

\* Except for doors with wicket doors



### Maintenance release directly on the operator

During the statutory annual door inspection, it is not necessary for the drive unit to be removed from the door shaft. It is only necessary to activate the maintenance release, saving time and money. The maintenance release can be converted to a secured release at any time.



### Optional push button control 300 U

Push button control 300 U (in the image above) forms a compact unit with dock leveller controls 420 S and 420 T. Combined with a dock leveller control with the new energy-saver function, this reduces energy consumption. Push button control 300 U is also optionally available with integrated main switch (not shown).

## Optional releases



### Secured release on inside

This allows you to conveniently release the operator from the floor (European patent).



### Secured release from outside ASE

To unlatch the door from the outside (required for buildings without a second entrance). Lockable diecast housing with profile half cylinder.

Dimensions:  
83 × 133 × 50 mm (W × H × D)

### Emergency operation

For manual operation of higher doors from 3000 mm (see figure on page 69)

### Emergency battery

With this emergency power in an external housing, you can bypass network power failures for up to 18 hours and max. 5 door cycles (dependent on the temperature and charge level). The emergency battery recharges itself during normal operation.

# Shaft operator WA 400, WA 400 M

Strong and robust

## Operator to flange WA 400

This patented flange version is simple and quick to fit to the spring shaft and requires considerably less sideroom than the direct drive solutions from other manufacturers.

**Can be combined with controls**  
A / B 445, A / B 460, B 460 FU



Standard fitting position: horizontal, alternatively vertical, shown with an optional emergency hand chain

## Operator with chain box WA 400

We recommend the WA 400 operator with chain box for all types of doors up to a height of 7500 mm if there is only sideroom of up to 200 mm. For applications L and LD, an operator with chain box is required. Due to the indirect transmission of forces, the door is subjected to minimum wear and friction.

**Can be combined with controls**  
A / B 445, A / B 460, B 460 FU



Standard fitting position: vertical, shown with an optional emergency hand chain

## Operator for central mounting WA 400 M

This version is mounted centrally on the spring shaft, as a result no additional sideroom is necessary. Note the required headroom!

The WA 400 M includes a secured release as a standard feature and is suitable for virtually any track application.

**Can be combined with controls**  
A / B 445, A / B 460, B 460 FU



Ideal option when sideroom is lacking.

**With all 3-phase current versions:**

- Exceptionally smooth running
- Long on-time
- Fast door travel
- Also as an FU version



**Standard maintenance release**

During the statutory annual door inspection, it is not necessary for the drive unit to be removed from the door shaft. It is only necessary to activate the maintenance release, saving time and money. The maintenance release can be converted to a secured release at any time.



**Optional emergency operation for maintenance release**

**Emergency crank handle**  
The low-cost option, available in two versions, as a fixed crank handle or jointed emergency crank handle. Retrofitting with an emergency hand chain is possible.



**Emergency hand chain**  
Through a combination of the emergency hand chain and the optional secured release, the door can be released or operated from the floor.



**Emergency operation**  
Recommended for doors over 3000 mm and fire station doors. A secured release is required.

**Meets the requirements of fire service directive EN 14092.**

**Optional releases**



**Secured release on inside**  
(As standard with WA 400 M)  
This allows you to conveniently release the operator from the floor (European patent).



**Secured release from outside ASE**  
To unlatch the door from the outside (required for buildings without a second entrance). Lockable diecast housing with profile half cylinder.  
Dimensions:  
83 x 133 x 50 mm (W x H x D)

# Operator SupraMatic HT ITO 400

The space-saving operator

## Chain drive with boom guidance ITO 400

- No sideroom required
- Emergency release via bowden cable on the slide carriage
- Emergency release from the outside possible
- IP 65 (jet-water protected)
- For normal track application (N, ND) and low headroom track application (L, LD)
- Max. door height 4500 mm
- Also available as FU version
- For doors with wicket doors on request

Can be combined with controls  
A / B 445, A / B 460 and B 460 FU

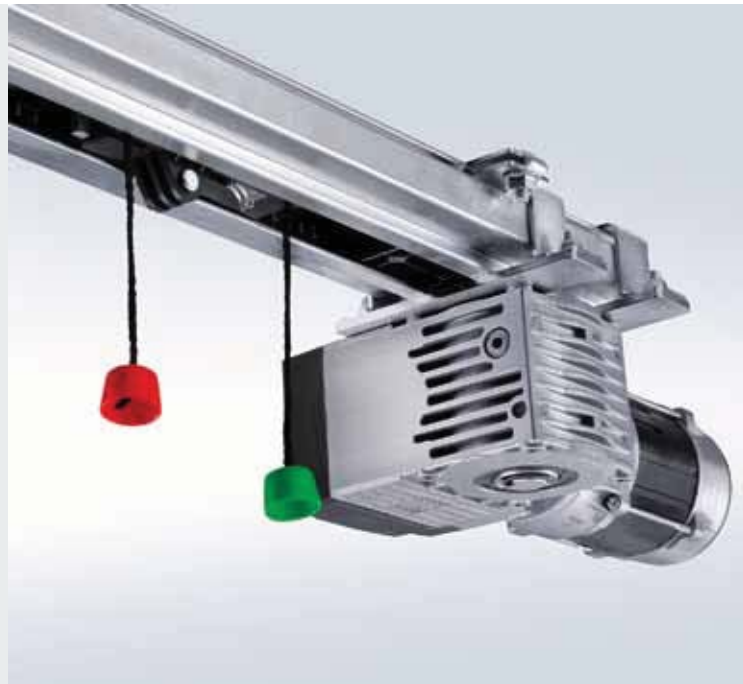

## Operator SupraMatic HT // NEW from July 2014

- Suitable for up to 100 parking spaces
- Pull and push force 1000 N (brief peak force 1200 N)
- With integrated control electronics including double 7-segment display for simple adjustment of the operator functions directly on the operator
- Optional external control 360 for connecting traffic control, warning lights or additional prints
- Soft start and stop for gentle, quiet door travel
- Patented door locking in the operator boom with emergency release from inside
- Connecting lead with EEC plug, second suspension for boom FS 60 and FS 6
- For doors with a spring safety device
- SupraMatic HT: max. width 6750 mm (7000 mm on request), max. height 3000 mm
- For normal track application (N) and low headroom track application (L)
- For doors with wicket doors, ALR F42 Glazing and real glass on request
- Not for sectional doors with a depth of 67 mm



# Standard security

## Thanks to a break-in-resistant arrestor kit

### Tightly locked and protected against forced opening

It is especially important for industrial doors to be reliably break-in-resistant to protect your goods and machines. All Hörmann power-driven doors up to 5 m high are equipped with a mechanical anti-lift kit. Hörmann offers optional locking systems for special protection.

### Standard for doors up to 5 m height

At Hörmann, all industrial sectional doors up to 5 m height equipped with operators WA 300 S4/WA 400 are supplied with a break-in-resistant arrestor kit as standard. This mechanical protection reliably prevents the door from being forcefully pushed open, even in case of a power failure.

Industrial sectional doors over 5 m high are break-in resistant due to their heavy weight.

In sectional doors with rail-guided operators, self-locking gearboxes protect against forced opening.

### Increased security for night doors

In power-driven doors, an additional mechanical shootbolt can be installed (see the figure on page 58). Because it is equipped with a shoot-bolt switch, the operator cannot be started if the door is locked.



The locking hook of the arrestor kit automatically latches if the door is forced upwards.

# Controls

## Compatible system solutions



	Internal control WA 300 S4	External control 360	Impulse control A / B 445	Comfort control A / B 460	FU control B 460 FU
--	-------------------------------	-------------------------	------------------------------	------------------------------	------------------------

### Operators

WA 300 S4	●	○			
WA 400			●	●	
WA 400 FU					●

### Functions / features

Control and operator can be mounted separately		●	●	●	●
Adjustments made conveniently directly on the control		●	●	●	●
Soft start and soft stop for gentle and quiet door travel	●	●			●
Adjustable high-speed opening and closing (depending on tracks)	● <sup>1)</sup>	● <sup>1)</sup>			●
Power limit in Open and Close directions	● <sup>2)</sup>	● <sup>2)</sup>	●	●	●
Integrated Open / Stop / Close operation	●	●	●	●	●
Second opening height with additional button on the housing cover	○ <sup>3)</sup>	●		●	●
Menu reading from outside with a double 7-segment display (maintenance, cycle and operating hours counters as well as error analysis)		●	●	●	●
Collective malfunction signalling with on-site individual display (acoustic, visual, or e.g. via mobile phone).		●	○	○	○
Extension possible with external radio receiver	●	●	●	●	●
Inquiry of the door position	○ <sup>4)</sup>	○ <sup>5)</sup>	○ <sup>5)</sup>	○ <sup>5)</sup>	○ <sup>5)</sup>
Automatic timer <sup>6)</sup>	●	●		●	●
Traffic control <sup>6)</sup>		○		○	○
Connecting terminals for additional command units	○	●	●	●	●

Power supply	230 V	230 V	400 / 230 V	400 / 230 V	230 V
Connection cable with CEE plug <sup>7)</sup> (Protection category IP 44)	●	●	●	●	●
Main switch integrated into control housing	○ <sup>8)</sup>	○	○	○	○
Protection category IP 65 (jet-water protected) for controls and door leaf components	●	●	●	●	●

● = as standard

○ = with corresponding equipment possibly with additional control

<sup>1)</sup> In the Close direction during operation without SKS / VL (during operation with SKS / VL, the door generally travels at high speed in the Close direction)

<sup>2)</sup> In accordance with EN 12453

<sup>3)</sup> Possible in combination with UAP 300 and DTH I or DTH IM

<sup>4)</sup> In combination with ESEi BS and HS 5 BS

<sup>5)</sup> In combination with HET-E2 24 BS, HS 5 BS and end-of-travel feedback

<sup>6)</sup> Only in combination with an activating kit for warning light and photocell or light grille or leading photocell VL 1 / VL 2

<sup>7)</sup> For controls with integrated main switch the connecting cable is omitted

<sup>8)</sup> External main switch possible or through operating unit 300 U with integrated main switch



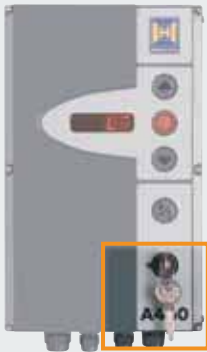

**Optional  
Profile half cylinder**

For all external controls



**Optional  
Main switch**

For all external controls

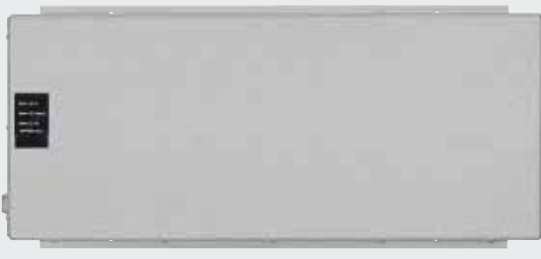

**UPS system**

For bridging power failures of up to 4 hours, safety devices, warning lights, etc., remain functional, LED status display, automatic battery test, surge filter,  
Dimensions: 560 × 235 × 260 mm (W × H × D),  
Protection category: IP 20

For controls  
360, B 445, B 460

**Optional  
Key switch post ST1 1**

For installing a maximum of 2 controls with additional housing.  
Colour: White aluminium, RAL 9006,  
Dimensions:  
200 × 60 mm,  
Height 1660 mm

# Accessories

## Radio control, receiver



**Only from Hörmann**

PATENT PENDING

## Hörmann BiSecur (BS)

### The modern radio system for industrial door operators

The bi-directional BiSecur radio system is based on future-oriented technology for the convenient and secure operation of industrial doors. The extremely secure BiSecur encryption protocol makes sure that no-one can copy your radio signal. It was tested and certified by security experts at Bochum University.

#### Your advantages

- 128-bit encryption with the same high security level as in online banking
- Interference-resistant radio signal with a stable range
- Convenient inquiry of the door position\*
- Backwards compatible, that means radio receivers with the frequency 868 MHz (2005 to June 2012) can also be operated with the BiSecur control elements



#### 5-button hand transmitter HS 5 BS

With additional button for querying the door position\*, black or white textured, with chrome caps

#### 5-button hand transmitter HS 5 BS

**// NEW from July 2014**  
With additional button for querying the door position\*, black textured, with chrome caps

#### 4-button hand transmitter HS 4 BS

High-gloss black, with chrome caps

#### 1-button hand transmitter HS 1 BS

High-gloss black, with chrome caps



#### 4-button security hand transmitter HSS 4 BS

Additional function: copy protection for hand transmitter coding, with chrome caps

#### 2-button hand transmitter HSE 2 BS

High-gloss black or white, with chrome caps

#### 2-button hand transmitter HSE 2 BS

**// NEW from July 2014**  
Black textured with chrome or plastic caps

#### 1-button hand transmitter HSE 1 BS

**// NEW from July 2014**  
High-gloss black, with chrome caps

\* With WA 300 S4 with optional bi-directional receiver ESEi BS, for all other operators with optional bi-directional receiver HET-2 24 BS and end-of-travel feedback.



**Industrial hand transmitter  
HSI BS**  
To control up to 1000 doors,  
with a display and extra-large  
quick selection buttons  
for easier operation with work  
gloves, transferring of hand  
transmitter coding to other  
devices possible



**Radio code switch  
FCT 3 BS**  
With illuminated buttons  
3 function codes



**Radio code switch  
FCT 10 BS**  
with illuminated buttons  
and protective cover, 10 function  
codes



**Radio finger-scan  
FFL 12 BS**  
2 function codes  
and up to 12 fingerprints



**1-channel relay receiver  
HER 1 BS**  
With volt-free relay output



**2-channel relay receiver  
HER 2 BS**  
With 2 volt-free relay outputs  
and external antenna



**2-channel relay receiver  
HET-E2 24 BS**  
**NEW from July 2014**  
With 2 volt-free relay outputs  
for choosing the direction, a 2-pin  
input for volt-free Open and Close  
limit switch reporting, for querying  
the door position



**4-channel relay receiver  
HER 4 BS**  
With 4 volt-free relay outputs



**3-channel receiver  
HEI 3 BS**  
For controlling 3 functions



**Bi-directional receiver  
ESEi BS // NEW**  
For querying door position



# Accessories

## Push button



### Push button DTH R

For separate control of both operational directions, with separate stop button, Protection category: IP 65  
Dimensions: 90 × 160 × 55 mm (W × H × D)

#### For controls

**360, A / B 445, A / B 460, B 460 FU and integrated control WA 300 S4**



### Push button DTH RM

For separate control of both operational directions, with separate stop button, With miniature lock: Operator is deactivated. The operator can no longer be actuated (2 keys included in the scope of delivery).

Protection category: IP 65  
Dimensions: 90 × 160 × 55 mm (W × H × D)

#### For controls

**360, A / B 445, A / B 460, B 460 FU and integrated control WA 300 S4**



### Push button DTH I

To move the door into the Open / Close positions, separate stop button to stop door travel, 1/2-open button to open the door up to the programmed intermediate travel limit, Protection category: IP 65  
Dimensions: 90 × 160 × 55 mm (W × H × D)

#### For controls

**360, A / B 460, B 460 FU and integrated control WA 300 S4** (only in combination with UAP 1)



### Push button DTH IM

To move the door into the Open / Close positions, separate stop button to stop door travel, 1/2-open button to open the door up to the programmed intermediate travel limit, with miniature lock: operator is deactivated. It is not possible to move the operator (2 keys included in the scope of delivery).

Protection category: IP 65

Dimensions: 90 × 160 × 55 mm (W × H × D)

#### For controls

**360, A / B 460, B 460 FU and integrated control WA 300 S4** (only in combination with UAP 1)



### Push button DT 02

Open or close via a command button, separate stop button, Dimensions: 65 × 112 × 68 mm (W × H × D)  
Protection category: IP 65

#### For controls

**A / B 445, A / B 460 and B 460 FU**



### Push button DT 03

For separate control of both operational directions, with separate stop button, Dimensions: 66 × 155 × 85 mm (W × H × D)  
Protection category: IP 65

#### For controls

**A / B 445, A / B 460 and B 460 FU**



### Push button DT 04

For separate control of both operational directions, with separate stop button, full or partial door opening (via separate button), Dimensions: 69 × 185 × 91 mm (W × H × D),  
Protection category: IP 65

#### For controls

**A / B 460 and B 460 FU**



### Push button DTN A 30

For separate control of both operational directions. The stop button is a push-to-lock button which, once pressed, stays depressed in order to prevent unauthorised operation. Subsequent operation is then only possible once the stop button has been unlocked with a key (2 keys included in the scope of delivery).  
Dimensions: 66 × 145 × 85 mm (W × H × D)  
Protection category: IP 65

#### For controls

**A / B 445, A / B 460 and B 460 FU**

# Accessories

## Push button, key switch, key switch post



### Push button DTP 02

Open or close via a command button, separate stop button and operation control light for control voltage, lockable with profile half cylinder (available as an accessory),  
Dimensions:  
86 x 260 x 85 mm (W x H x D)  
Protection category: IP 44

#### For controls

A / B 445, A / B 460 and B 460 FU



### Push button DTP 03

For separate control of both operational directions, separate stop button and operation control light for control voltage, lockable with profile half cylinder (available as an accessory),  
Dimensions:  
68 x 290 x 74 mm (W x H x D)  
Protection category: IP 44

#### For controls

A / B 445, A / B 460 and B 460 FU



### Emergency-off button DTN 10

To quickly immobilise the door, push-to-lock button (mushroom button), surface-mounted,  
Dimensions:  
93 x 93 x 95 mm (W x H x D)  
Protection category: IP 65

#### For controls

A / B 445, A / B 460 and B 460 FU



### Emergency-off button DTNG 10

To quickly immobilise the door, oversized push-to-lock mushroom button, surface-mounted,  
Dimensions:  
93 x 93 x 95 mm (W x H x D)  
Protection category: IP 65

#### For controls

A / B 445, A / B 460 and B 460 FU

The lockable function serves to isolate the control voltage and immobilises the command units. Profile half cylinders are not included in the scope of delivery for the push buttons.



### Key switch ESU 30 with 3 keys

Recessed version, Impulse or Open / Close function selectable,  
Dimensions of switch box:  
60 mm (d), 58 mm (D)  
Dimensions of cover:  
90 x 100 mm (W x H),  
Wall recess:  
65 mm (d), 60 mm (D)  
Protection category: IP 54

Surface-mounted version ESA 30 (not shown)

Dimensions:  
73 x 73 x 50 mm (W x H x D)



### Key switch STUP 30 with 3 keys

Recessed version, Impulse or Open / Close function selectable,  
Dimensions of switch box:  
60 mm (d), 58 mm (D)  
Dimensions of cover:  
80 x 110 mm (W x H)  
Wall recess:  
65 mm (d), 60 mm (D)  
Protection category: IP 54

Surface-mounted version STAP 30 (not shown)

Dimensions:  
80 x 110 x 68 mm (W x H x D)



### ZT 2 pull switch with cord

Impulse generation to open or close the door  
Dimensions:  
60 x 90 x 55 mm (W x H x D)  
Pull cord length: 3.2 m,  
Protection category: IP 65

Cantilever arm KA1 (not shown)  
Extension 1680 - 3080 mm.  
Can be used with ZT 2



### Key switch post STS 1

With adapter for fitting TTR 100, FCT 10 b, CTR 1b / CTR 3b or STUP. The command units must be ordered separately. The post is anodised aluminium (natural finish). Top and bottom end of post in Slate grey, RAL 7015.  
Dimensions:  
300 mm (d), 1250 mm (H)  
Protection category: IP 44

Version with fitted key switch STUP 30 (accessory)

# Accessories

## Code switch



### Code switch CTR 1b, CTR 3b

The code switches CTR 1b and CTR 3b offer a high level of security against unauthorised opening. Simply enter your personal code; a key is no longer required.  
The deluxe version CTR 3b allows you to open a second door and switch on the outside lighting or operate a door in your choice of direction.

#### Dimensions:

80 × 110 × 17 mm (W × H × D),

Decoder housing:

140 × 130 × 50 mm (W × H × D)

Keypad protection category: IP 65

Decoder housing protection category: IP 54

Switching capacity: 2.5 A / 30 V DC

500 W / 250 V AC



### Code switch CTV 1, CTV 3

The code switches are especially robust and protected against vandalism. To operate, you enter your own personal code – no key is needed.  
With the CTV 3 comfort version, you can open a second door and also switch on the outside lights or operate a door in the chosen direction.

#### Dimensions:

75 × 75 × 13 mm (W × H × D),

Decoder housing:

140 × 130 × 50 mm (W × H × D)

Keypad protection category: IP 65

Decoder housing protection category: IP 54

Switching capacity: 2.5 A / 30 V DC

500 W / 250 V AC



### Finger-scan FL 12, FL 100

A fingerprint is enough to securely and conveniently open your industrial sectional door. The finger-scan is available in two versions, as an FL 12 or FL 100 to store 12 or 100 fingerprints, respectively.

#### Dimensions:

80 × 110 × 39 mm (W × H × D)

Decoder housing:

70 × 275 × 50 mm (W × H × D)

Reader protection category: IP 65

Decoder housing protection category: IP 56

Switching capacity: 2.0 A / 30 V DC



### Transponder key switch TTR 100 / TTR 1000

The convenient solution when several persons require access to the building. You simply hold the transponder key with your personal security code approx. 2 cm in front of the reader. A non-contact system! A major benefit in the dark. 2 keys are included. Suitable for max. 100 transponder keys (TTR 100) or 1000 transponder keys (TTR 1000).

#### Dimensions:

80 × 110 × 17 mm (W × H × D),

Decoder housing:

140 × 130 × 50 mm (W × H × D)

Transponder pad protection category: IP 65

Decoder housing protection category: IP 54

Switching capacity: 2.5 A / 30 V DC

500 W / 250 V AC

# Accessories

## Activating kit, LED warning lights



**Warning lights with bright, long-lasting LEDs**



**Multi-function circuit board to be fitted in existing housing or optionally in separate extension housing (fig.)**

Limit switch reporting, momentary impulse, collective malfunction signalling, extension unit for controls 360, A / B 445, A / B 460, B 460 FU

Dimensions of additional housing: 202 x 164 x 130 mm (W x H x D),  
Protection category: IP 65  
A circuit board can be optionally mounted in the control.



**Digital weekly timer in a separate additional housing**

The timer can switch command units on and off via a volt-free contact.  
Extension unit for controls A / B 460, B 460 FU, 360 (no additional housing, for fitting in an existing housing),  
switching capacity: 230 V AC: 2.5 A / 500 W,  
Can be switched over to summer / winter time  
Manual switching: automatic operation, switching preselection permanently ON / OFF

Dimensions of additional housing: 202 x 164 x 130 mm (W x H x D),  
Protection category: IP 65



**Summer / winter activating kit in an additional housing**

Function for full opening of door and individually programmable intermediate travel limit  
Extension unit for controls A / B 460, B 460 FU

Dimensions of additional housing: 202 x 164 x 130 mm (W x H x D),  
Protection category: IP 65



**Activating kit for warning light for fitting in an existing housing or optionally in a separate extension housing (fig.), incl. 2 yellow warning lights**

Extension unit for controls 360, A / B 445, A / B 460, B 460 FU.  
The activating kit for warning lights serves as a visual indicator while the door is moving (weekly timer, optionally for 360, A / B 460, B 460 FU).  
Applications: approach warning (for 360, A / B 445, A / B 460, B 460 FU), automatic timer (for 360, A / B 460, B 460 FU).  
After the set hold-open phase has elapsed (0 – 480 s), the warning lights flash during the set pre-warning phase (0 – 70 s).  
Traffic light dimensions: 180 x 250 x 290 mm (W x H x D),  
Dimensions of additional housing: 202 x 164 x 130 mm (W x H x D),  
contact load: 250 V AC: 2.5 A / 500 W,  
protection category: IP 65



**Traffic control in separate additional housing (A / B 460, B 460 FU) or for fitting in an existing housing (360) incl. 2 red / green warning lights**

Extension unit for controls 360, A / B 460, B 460 FU.  
The activating kit for warning lights serves as a visual indicator for regulating the entrance and exit (optional weekly timer).  
Duration of the green phase: Adjustable from 0 – 480 s  
Duration of the clearance phase: Adjustable from 0 – 70 s  
Traffic light dimensions: 180 x 410 x 290 mm (W x H x D),  
Dimensions of additional housing: 202 x 164 x 130 mm (W x H x D),  
Contact load: 250 V AC : 2.5 A / 500 W,  
Protection category: IP 65

# Accessories

## Activating kits



### DI 1 induction loop in a separate additional housing

Suitable for one induction loop.

The detector has a normally open contact and a change-over contact.

### DI 2 induction loop (not shown) in a separate additional housing

Suitable for two separate induction loops.

The detector has two volt-free normally open contacts.

Can be set for impulse or permanent contact, directional recognition possible

Dimensions of additional housing:

202 × 164 × 130 mm (W × H × D)

Switching capacity:

DI 1: low voltage 2 A, 125 V A/60 W,

DI 2: 250 V AC, 4 A, 1000 VA, (resistivity AC)

Supplied without loop cable

### Loop cable for induction loop

50 m roll,

cable designation: SIAF,

cross-section: 1.5 mm<sup>2</sup>,

colour: brown

### Radar movement detector RBM 2

For "Open door" impulse with directional recognition

Max. fitting height: 6 m Dimensions:

155 × 132 × 58 mm (W × H × D)

Contact load:

24 AC / DC, 1 A (resistivity),

Protection category: IP 65

### Remote control for radar movement detector optional



### UAP 300

#### For WA 300 S4

For impulse selection, partial opening function, limit switch reporting and activating kit for warning light with 2 m system cable,

Protection category: IP 65

Max. switching capacity:

30 V DC / 2.5 A (resistivity),

250 V AC / 500 W (resistivity),

Dimensions: 110 × 45 × 40 mm (W × H × D)

### HOR 300

#### For WA 300 S4

To control limit switch reporting or warning lights with 2 m connecting lead,

Protection category: IP 44

Max. switching capacity:

30 V DC / 2.5 A (resistivity),

250 V AC / 500 W (resistivity),

Dimensions: 110 × 45 × 40 mm (W × H × D)



# Hörmann is your partner for special solutions

## Special control construction



Hörmann offers you a complete and individual control concept from a single source. From the integration of the Hörmann special control into your control concept, via a complete central control for all functional processes, up to PC-based visualisation of all door and loading components.



More information can be found in the Special control systems brochure.



Individual in-house project development

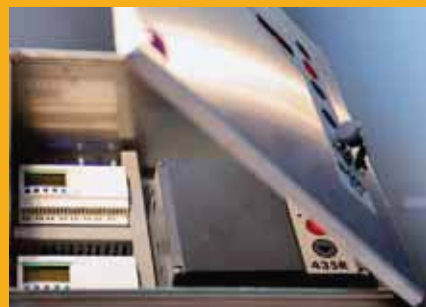

Modular solutions, compatible with the Hörmann operator technology



Controlled processes through visualisation on a control panel or web application

# Performance characteristics according to EN 13241-1

Door types	SPU F42	SPU 67 Thermo	APU F42	APU F42 Thermo	APU 67 Thermo	ALR F42	ALR F42 Thermo	ALR 67 Thermo	
<b>Wind load</b>	Class according to EN 12424								
Up to door widths of 8000 mm	3 <sup>1)</sup>	3 <sup>1)</sup>	3 <sup>1)</sup>	3 <sup>1)</sup>	3 <sup>1)</sup>	3 <sup>1)</sup>	3 <sup>1)</sup>	3 <sup>1)</sup>	
From door widths of 8000 mm		2			2			2	
<b>Water tightness</b>	Class according to EN 12425								
	3 (70 Pa)	3 (70 Pa)	3 (70 Pa)	3 (70 Pa)	3 (70 Pa)	3 (70 Pa)	3 (70 Pa)	3 (70 Pa)	
<b>Air permeability</b>	Class according to EN 12426								
Sectional door without wicket door	2	2	2	2	2	2	2	2	
Sectional door with wicket door	1	1	1	1	1	1	1	1	
<b>Acoustic insulation <sup>2)</sup></b>	R [db] according to EN ISO 717-1								
Sectional door without wicket door	25	25	23	23	23	23	23	23	
With real glass panes						30	30	30	
Sectional door with wicket door	24	24	22	22	22	22	22	22	
<b>Thermal insulation</b>	U-value = W/(m <sup>2</sup> ·K) according to EN 13241, Appendix B, for a door size from 5000 × 5000 mm								
Sectional doors without wicket door									
Fitted door	1.0	0.62							
With ThermoFrame	0.94	0.51							
Synthetic double panes			3.4	2.9		3.6	3.0		
With ThermoFrame			3.3	2.8		3.6	3.0		
Synthetic triple panes			3.0	2.5	2.1	3.2	2.6	2.2	
With ThermoFrame			2.9	2.4	2.0	3.1	2.5	2.1	
Synthetic quadruple pane					1.8			1.9	
With ThermoFrame					1.7			1.8	
Climatic double pane			2.5	2.0	1.6	2.7	2.1	1.7	
With ThermoFrame			2.4	1.9	1.5	2.6	2.0	1.6	
Double real glass pane			3.4	2.9	2.6	3.6	3.0	2.7	
With ThermoFrame			3.3	2.8	2.5	3.6	3.0	2.6	
Single real glass pane									
With ThermoFrame									
<b>Thermal insulation</b>	U-value = W/(m <sup>2</sup> ·K) according to EN 13241, Appendix B, for a door size from 5000 × 5000 mm								
Sectional doors without wicket door									
Fitted door	1.2	0.82							
With ThermoFrame	1.2	0.75							
Synthetic double panes			3.6	3.1		3.8	3.2		
With ThermoFrame			3.6	3.1		3.8	3.2		
Synthetic triple panes			3.2	2.7	2.3	3.4	2.8	2.4	
With ThermoFrame			3.1	2.6	2.2	3.4	2.8	2.3	
Synthetic quadruple pane					2.0			2.1	
With ThermoFrame					1.9			2.1	

<sup>1)</sup> With wicket door and door wider than 4000 mm class 2

<sup>2)</sup> For combined infills the weaker is the most critical (e.g. APU, SPU with glazing frame).

	APU F42 S-Line	ALR F42 S-Line	ALR F42 Glazing	ALR 67 Thermo Glazing	ALR F42 Vitraplan
	3	3	3	3	3
	2			2	
	3 (70 Pa)	3 (70 Pa)	3 (70 Pa)	3 (70 Pa)	3 (70 Pa)
	2	2	2	2	2
	23	22	30	30	23
	3.3	3.5			3.2
	3.2	3.4			3.2
	2.8	3.0			3.1
	2.7	2.9			3.1
			2.7	1.8	
			2.6	1.7	
			3.8	3.0	
			3.8	2.9	
			6.1		
			6.1		

Glazings/infills	U <sub>g</sub> value W/(m <sup>2</sup> ·K)	τ <sub>v</sub> value	g-value
<b>Synthetic panes</b>			
<b>Single pane, 3 mm</b>			
Clear		0.88	
Crystal structure		0.84	
<b>Double pane, 26 mm</b>			
Clear	2.6	0.79	0.76
Crystal structure	2.6	0.74	
Grey tinted	2.6		
Brown tinted	2.6		
White tinted (opal)	2.6	0.60	
<b>Triple pane, 26 mm</b>			
Clear	1.9	0.71	0.69
Crystal structure	1.9		
Grey tinted	1.9		
Brown tinted	1.9		
White tinted (opal)	1.9	0.60	
<b>Triple pane, 51 mm</b>			
Clear	1.8		
Crystal structure	1.8		
Grey tinted	1.8		
Brown tinted	1.8		
White tinted (opal)	1.8		
<b>Quadruple pane, 51 mm</b>			
Clear	1.4		
Crystal structure	1.4		
Grey tinted	1.4		
Brown tinted	1.4		
White tinted (opal)	1.4		
<b>Polycarbonate panes</b>			
<b>Single pane, 6 mm</b>			
Clear			
<b>Double pane, 26 mm</b>			
Clear	2.6		
<b>Real glass panes</b>			
<b>Single pane, 6 mm</b>			
Clear	5.7	0.88	0.79
<b>Double pane, 26 mm</b>			
Clear	2.6	0.81	0.76
<b>Climatic double pane, 26 mm</b>			
Clear	1.1	0.80	0.64
<b>Infill</b>			
<b>Multiple-moulded pane</b>	1.9	0.52	

U<sub>g</sub> value Thermal insulation value  
τ<sub>v</sub> value Light transmission (transparency)  
g-value Total energy transmittance

# Construction and quality features

● = Standard  
○ = Optional

	SPU F42	SPU 67 Thermo	APU F42	APU F42 Thermo	APU 67 Thermo
<b>Construction</b>					
Self-supporting	●	●	●	●	●
Depth, mm	42	67	42	42	67
<b>Door sizes</b>					
Max. width mm, LZ	8000	10000	8000	7000	10000
Max. height mm, RM	7500	7500	7500	7500	7500
<b>Material, door leaf</b>					
Double-skinned steel section	●	-	●	●	-
Double-skinned steel section with thermal break	-	●	-	-	●
Aluminium profile	-	-	●	-	-
Aluminium profile with thermal break	-	-	-	●	●
<b>Surface, door leaf</b>					
Galvanized steel, coated RAL 9002	●	●	○	○	○
Galvanized steel, coated RAL 9006	○	○	●	●	●
Galvanized steel, coated RAL to choose	○	○	○	○	○
Anodised aluminium E6 / C0 (previously E6 / EV 1)	-	-	●	●	●
Aluminium coated in RAL to choose	-	-	○	○	○
<b>Wicket door</b>					
With trip-free threshold	○	○	○	○	○
<b>Side door</b>					
Matching the door	○	○	○	○	○
<b>Glazings</b>					
Type A section window	○	○	-	-	-
Type D section windows	○	○	-	-	-
Type E section windows	○	-	-	-	-
Aluminium glazing frames	○	○	●	●	●
<b>Seals</b>					
All-round on 4 sides	●	●	●	●	●
Intermediate seal between the door sections	●	●	●	●	●
<b>ThermoFrame</b>	○	○	○	○	○
<b>Locking systems</b>					
Internal latches	●	●	●	●	●
Outside / inside locking	○	○	○	○	○
<b>Arrestor kit</b>					
For doors of up to 5 m with shaft operator	●	●	●	●	●
<b>Safety equipment</b>					
Finger trap protection	●	-	●	●	-
Side trap guard	●	●	●	●	●
Safety catch for doors	●	●	●	●	●
<b>Fastening options</b>					
Concrete	●	●	●	●	●
Steel	●	●	●	●	●
Brickwork	●	●	●	●	●
Others on request					

	ALR F42	ALR F42 Thermo	ALR 67 Thermo	APU F42 S-Line	ALR F42 S-Line	ALR F42 Glazing	ALR 67 Thermo Glazing	ALR F42 Vitraplan
	● 42	● 42	● 67	● 42 / 48.5	● 48.5	● 42	● 67	● 42
	8000 7500	7000 7500	10000 7500	5000 7500	5000 7500	5500 4000	5500 4000	6000 7000
	- - ● -	- - - ●	- - - ●	● - ● -	- - ● -	- - ● -	- - - ●	- - ● -
	- - ● ○	- - ● ○	- - ● ○	○ ● ○ ○	- - ● ○	- - ● ○	- - ● ○	- - - ●
	○	○	○	-	-	-	-	-
	○	○	○	○	○	○	○	○
	- - - ●	- - - ●	- - - ●	- - - ●	- - - ●	- - - ●	- - - ●	- - - ●
	● ● ○	● ● ○	● ● ○	● ● ○	● ● ○	● ● ○	● ● ○	● ● ○
	● ○	● ○	● ○	● ○	● ○	● -	● -	● -
	●	●	●	●	●	●	●	●
	● ● ●	● ● ●	- ● ●	● ● ●	● ● ●	● ● ●	- ● ●	● ● ●
	● ● ●	● ● ●	● ● ●	● ● ●	● ● ●	● ● ●	● ● ●	● ● ●

# Hörmann product range

Everything from a single source for your construction project

## 1 Sectional doors

These space-saving door systems can be adapted to different industrial facilities using various track applications. Hörmann offers you tailored solutions for every application.

## 2 Rolling shutters and rolling grilles

Thanks to a simple construction with just a few components, rolling shutters are both economical and sturdy. Hörmann supplies rolling shutters in widths and heights of up to 11.75 m and 9 m respectively, or as special doors which are even larger.

## 3 High-speed doors

Hörmann high-speed doors are used both inside and as exterior doors to optimise the flow of traffic, improve room conditions and save energy. The Hörmann programme includes vertically and horizontally opening transparent doors with flexible curtains.

## 4 Loading technology

Hörmann offers you complete loading systems for the logistics sector. The advantages: reliable planning, dependable execution of construction work and high functionality thanks to precisely matched components.

## 5 Fire and multi-purpose sliding doors

Hörmann can provide you with single or double-leaf sliding door solutions suitable for all areas and required fire protection classes, or without fire protection.

## 6 Multi-function doors and reinforced internal doors

Hörmann multi-function doors and reinforced internal doors are suitable for indoor and outdoor use. Our single and double-leaf doors can be used wherever robust door elements are required. With numerous additional functions, such as fire and smoke protection, acoustic insulation or burglar protection.

## 7 Box frame parts

For areas in which appearance is important, such as administrative buildings, Hörmann offers you fire and smoke protection doors as well as steel and aluminium fixed glazing and automatic sliding doors, also suited for special fire protection requirements.

## 8 Visibility windows

Hörmann visibility glazings are used as windows or room-high elements to provide more light and better visibility.

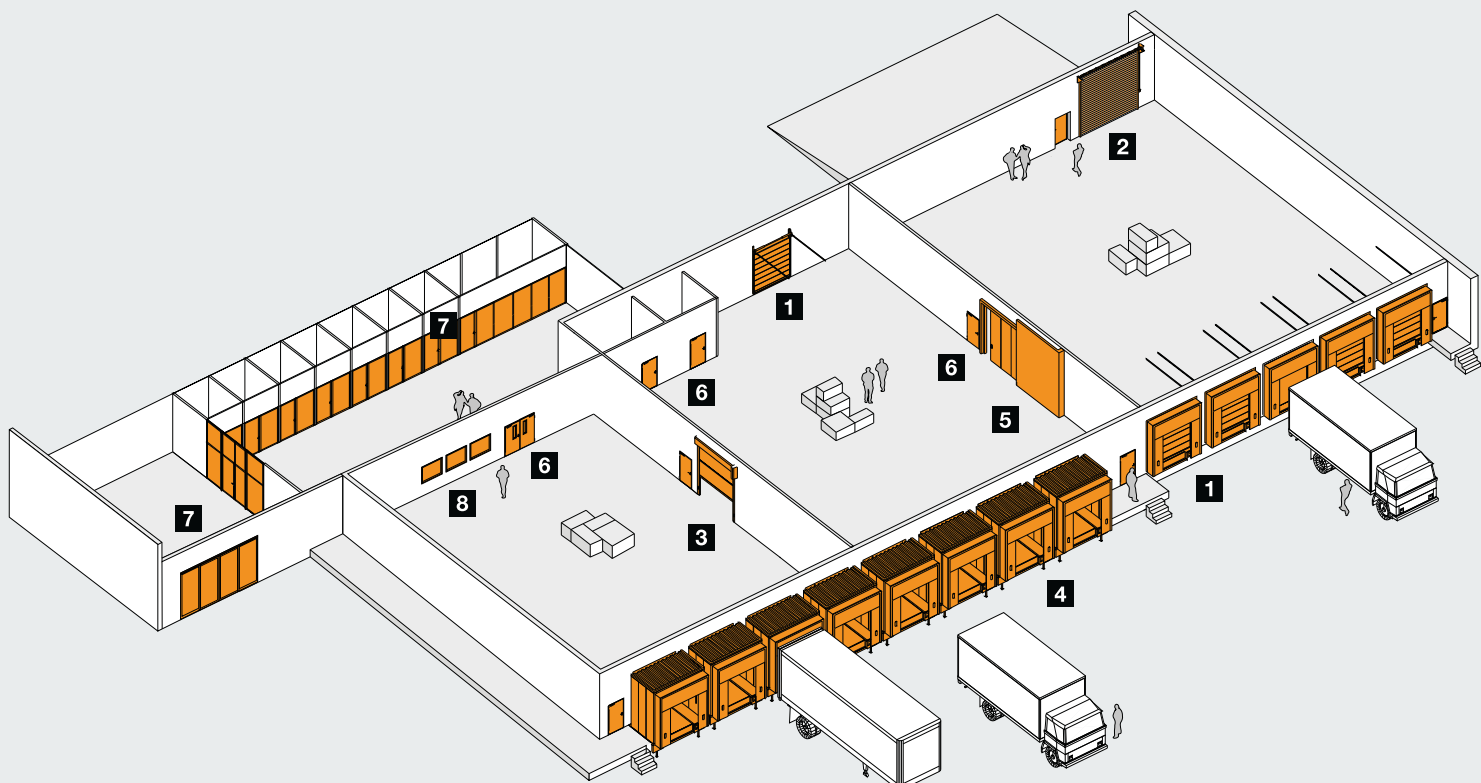



**Quick service with testing,  
maintenance and repairs**  
Our extensive service network  
means that we are always nearby  
and at your service around the clock.



# Hörmann: Quality without Compromise



Hörmann KG Amshausen, Germany



Hörmann KG Antriebstechnik, Germany



Hörmann KG Brandis, Germany



Hörmann KG Brockhagen, Germany



Hörmann KG Dissen, Germany



Hörmann KG Eckelhausen, Germany



Hörmann KG Freisen, Germany



Hörmann KG Ichttershausen, Germany



Hörmann KG Werne, Germany



Hörmann Genk NV, Belgium



Hörmann Alkmaar B.V., Netherlands



Hörmann Legnica Sp. z o.o., Poland



Hörmann Beijing, China



Hörmann Tianjin, China



Hörmann LLC, Montgomery IL, USA



Hörmann Flexon, Leetsdale PA, USA

Hörmann is the only manufacturer worldwide that offers you a complete range of all major building products from one source. We manufacture in highly-specialised factories using the latest production technologies. The close-meshed network of sales and service companies throughout Europe, and activities in the USA and China, make Hörmann your strong partner for first-class building products, offering "Quality without Compromise".

**GARAGE DOORS**  
**OPERATORS**  
**INDUSTRIAL DOORS**  
**LOADING EQUIPMENT**  
**HINGED DOORS**  
**DOOR FRAMES**

 door  
studio  
[www.doorstudio.ca](http://www.doorstudio.ca)

7401 Pacific Circle,  
Mississauga, ON  
L5R 4B1  
Tel 905.755.9448  
[info@doorstudio.ca](mailto:info@doorstudio.ca)

